



**CARATTERISTICHE COSTRUTTIVE / CONSTRUCTION FEATURES
CARACTERÍSTICAS CONSTRUCTIVAS / CARACTÉRISTIQUES D'EXÉCUTION**

Corpo pompa	ghisa
Pump body	cast iron
Cuerpo bomba	fundición
Corps de pompe	fonte
Supporto motore	ghisa
Motor bracket	cast iron
Soporte motor	fundición
Support moteur	fonte
Girante	ghisa o bronzo
Impeller	cast iron or bronze
Rodete	fundición o bronce
Turbine	fonte ou bronze
Tenuta meccanica	ceramica-grafite
Mechanical seal	ceramic-graphite
Sello mecánico	cerámica-grafito
Garniture mécanique	céramique-graphite
Albero motore	acciaio AISI 304
Motor shaft	stainless steel AISI 304
Eje motor	acero AISI 304
Arbre moteur	acier AISI 304
Temperatura del liquido	
Liquid temperature	
Temperatura del líquido	-10 ÷ +90 °C
Température du liquide	
Pressione di esercizio	
Operating pressure	max 10 bar
Presión de trabajo	
Pression de fonctionnement	

MOTORE / MOTOR / MOTOR / MOTEUR

Motore 2 poli a induzione	
2 pole induction motor	3~ 230/400V-50Hz
Motor de 2 polos a inducción	1~ 230V-50Hz
Moteur à induction à 2 pôles	
Classe di isolamento	
Insulation class	F
Clase de aislamiento	
Classe d'isolation	
Grado di protezione	
Protection degree	IP55
Grado de protección	
Protection	

Pompe centrifughe monoblocco ad asse orizzontale costruite secondo le norme EN 733; trovano vasto utilizzo nell'alimentazione idrica, negli impianti di pressurizzazione e antincendio, raffreddamento, riscaldamento, irrigazione, applicazioni agricole e industriali; come standard vengono fornite di controflangia.

Monobloc horizontal centrifugal pumps, constructed to EN 733 standards; widely used in water supplies, pressurisation and fire-fighting systems, cooling, heating, irrigation, industrial and agricultural applications; standard supply with counter-flange.

Bombas centrífugas monobloque de eje horizontal fabricadas según las normas EN 733; se utilizan en gran parte en la alimentación hídrica, en las instalaciones de presurización y antiincendio, enfriamiento, calefacción, riego, aplicaciones agrícolas e industriales; según el estándar se suministran con contrabrida.

Pompes centrifuges monobloc à axe horizontal, fabriquées conformément aux normes EN 733. Elles trouvent une ample utilisation dans l'approvisionnement d'eau, dans les installations de pressurisation et anti-incendie, refroidissement, chauffage, irrigation, applications agricoles et industrielles; fournies de série avec contre-bride.

MN 32-160

MN 32-200

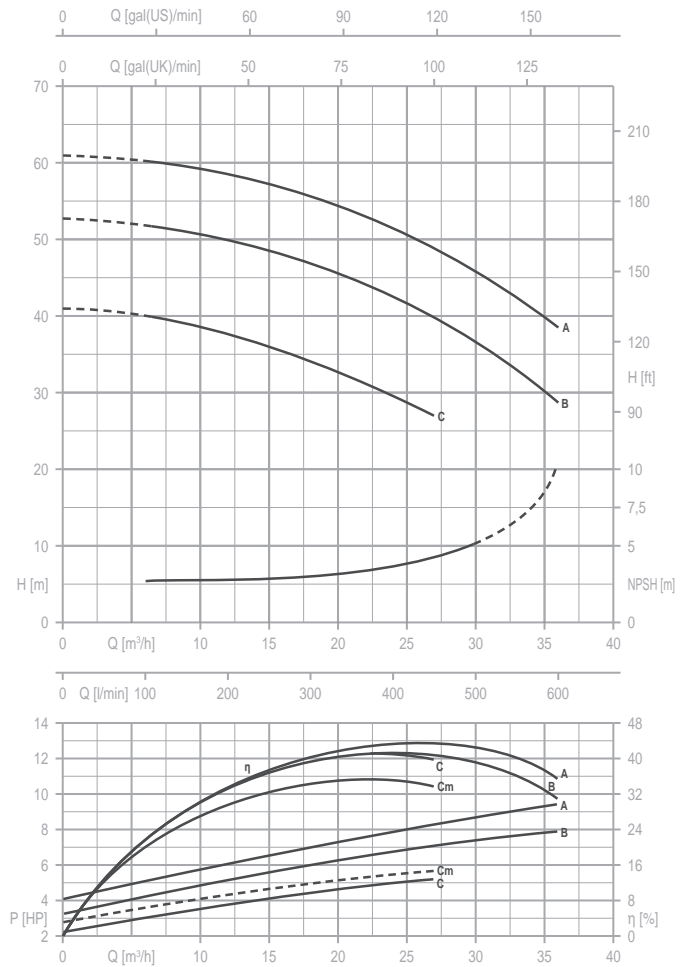
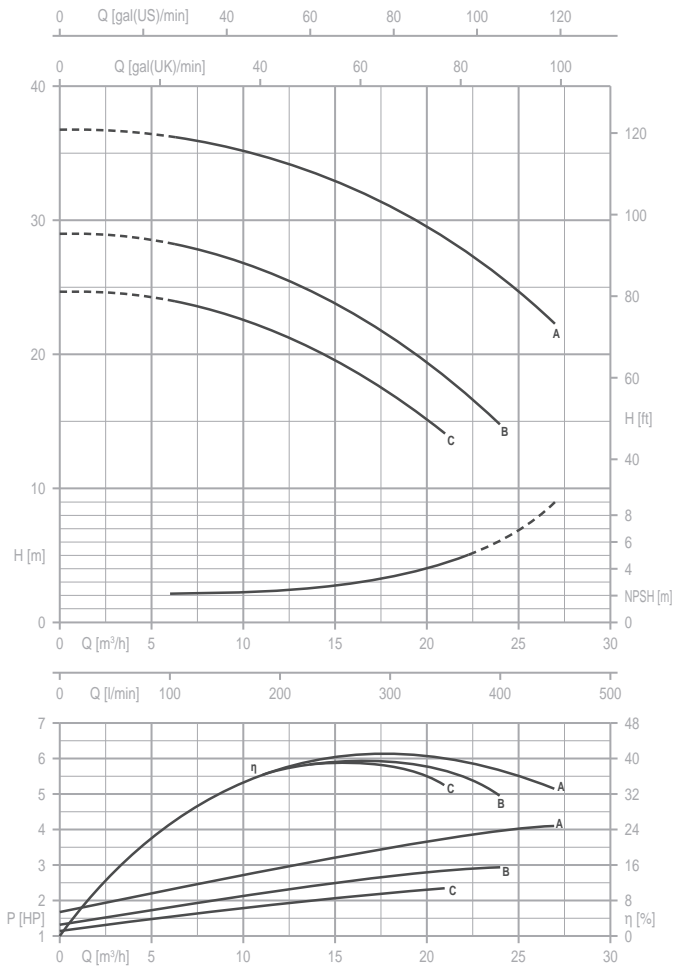

TYPE	P2		P1 (kW)	AMPERE	Q (m³/h - l/min)										
					H (m)										
					0	4.5	6	7.5	9	12	15	18	21	24	27
3~	(HP)	(kW)	3~	0	75	100	125	150	200	250	300	350	400	450	
				0	75	100	125	150	200	250	300	350	400	450	
MN 32-160 C (*)	2	1.5	2.3	4	24.7	24.4	24.1	23.6	23.0	21.5	19.6	17.2	14.1	-	-
MN 32-160 B	3	2.2	2.9	5.2	29.0	-	28.5	28.0	27.3	25.7	23.8	21.4	18.5	14.8	-
MN 32-160 A	4	3	4.1	7.1	36.8	-	36.4	36.0	35.4	34.2	32.8	31.1	28.8	26.0	22.3

(*) Disponibile nella versione monofase / Single phase available / Bajo pedido tambien en monofase / Disponible en monofase

TYPE	P2		P1 (kW)	AMPERE	Q (m³/h - l/min)												
					H (m)												
					0	6	7.5	9	12	15	18	21	24	27	30	33	36
3~	(HP)	(kW)	3~	0	100	125	150	200	250	300	350	400	450	500	550	600	
				0	100	125	150	200	250	300	350	400	450	500	550	600	
MN 32-200 C	5.5	4	5.2	9.4	41	40	39,5	38,9	37,5	36	34,2	32,2	30	27	-	-	-
MN 32-200 B	7.5	5.5	8.0	13.7	52,8	52	51,5	51	50	48,5	46,8	45	42,7	40,1	37	33,3	28,7
MN 32-200 A	10	7.5	9.9	16.5	61	60,5	60,1	59,6	58,5	57,2	55,5	53,7	51,5	49	46,2	42,7	38,5

MN 32-250

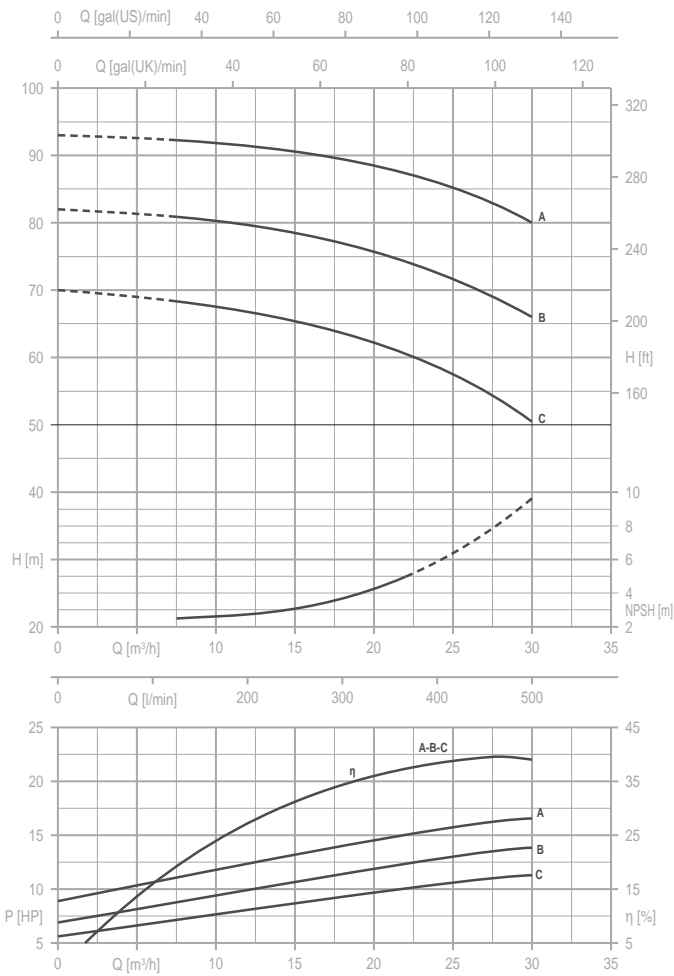

MN 40-125

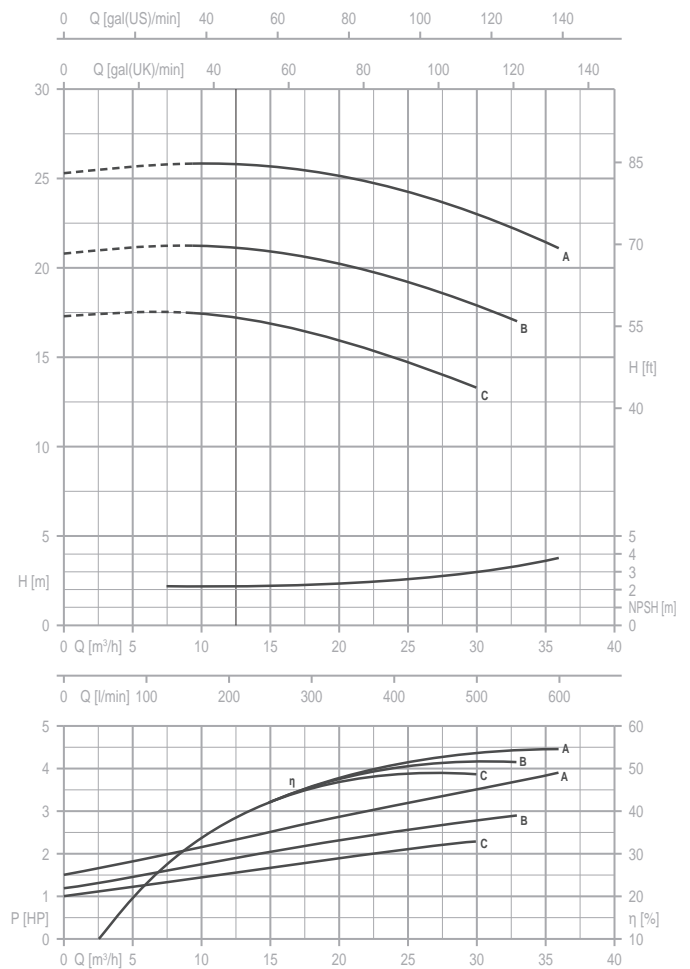

TYPE	P2		P1 (kW)	AMPERE	Q (m³/h - l/min)										
					3~	0	7.5	9	12	15	18	21	24	27	30
						0	125	150	200	250	300	350	400	450	500
3~	(HP)	(kW)	3~	3x400 V 50 Hz	H (m)										
MN 32-250 C	12.5	9.2	11.9	20.1	70.0	68,5	68	67	65,5	63,5	61,5	58,7	55	50,5	
MN 32-250 B	15	11	14.4	24.2	82.0	81	80,5	79,5	78,5	77	75	72,6	70	66,5	
MN 32-250 A	20	15	18.1	30.1	93.0	92,5	92	91,5	90,5	89,5	88	85,7	83,5	80	

TYPE	P2		P1 (kW)	AMPERE	Q (m³/h - l/min)												
					3~	0	7.5	9	12	15	18	21	24	27	30	33	36
						0	125	150	200	250	300	350	400	450	500	550	600
3~	(HP)	(kW)	3~	3x400 V 50 Hz	H (m)												
MN 40-125 C	2	1.5	2.3	4.0	17.4	17.6	17.5	17.3	16.9	16.4	15.8	15.1	14.2	13.3	-	-	
MN 40-125 B	3	2.2	2.9	5.2	20.7	-	21.3	21.2	21.0	20.6	20.1	19.4	18.7	17.9	17.0	-	
MN 40-125 A	4	3	4.1	7.1	25.2	-	25.8	25.8	25.6	25.4	24.9	24.4	23.7	22.9	22.0	21.1	

MN 40-160

MN 40-200

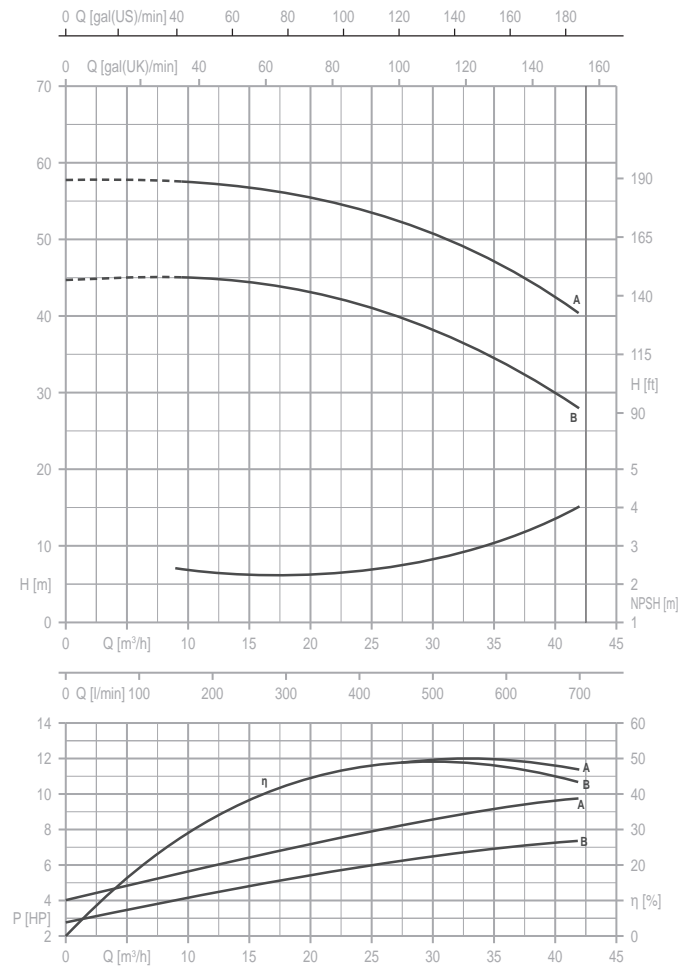
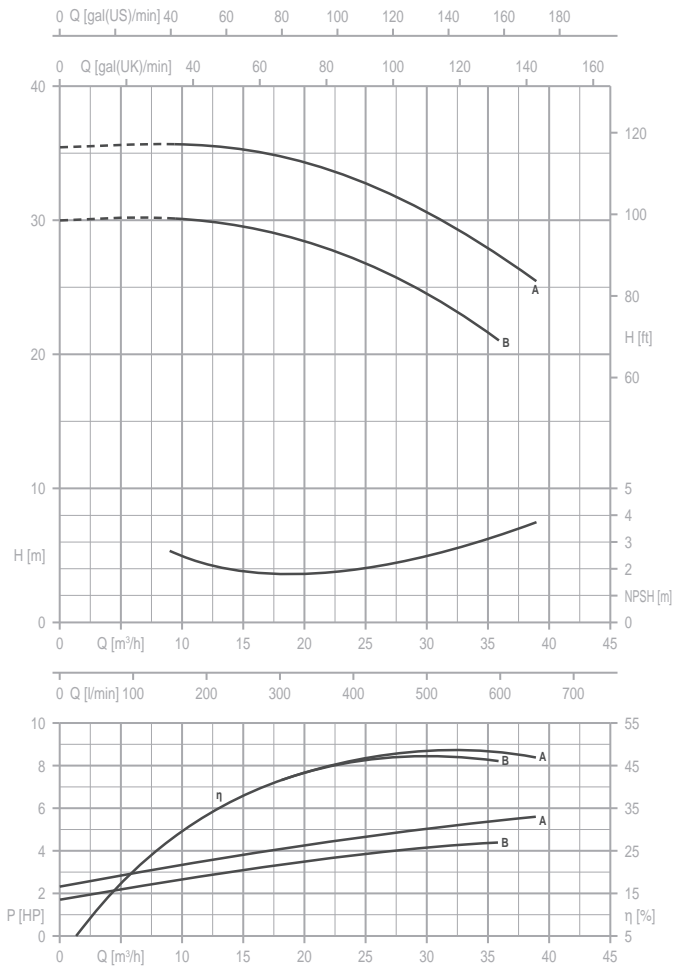

TYPE	P2		P1 (kW)	AMPERE	Q (m³/h - l/min)												
					3~	0	9	12	15	18	21	24	27	30	33	36	39
						0	150	200	250	300	350	400	450	500	550	600	650
	(HP)	(kW)	3~	3x400 V 50 Hz	H (m)												
MN 40-160 B	4	3	4.4	7.4	30.0	30.1	30.0	29.6	29.0	28.2	27.1	25.9	24.4	22.8	21.0	-	
MN 40-160 A	5.5	4	5.7	9.9	35.4	35.6	35.5	35.3	35.0	34.2	33.2	32.0	30.6	29.0	27.3	25.4	

TYPE	P2		P1 (kW)	AMPERE	Q (m³/h - l/min)													
					3~	0	9	12	15	18	21	24	27	30	33	36	39	42
						0	150	200	250	300	350	400	450	500	550	600	650	700
	(HP)	(kW)	3~	3x400 V 50 Hz	H (m)													
MN 40-200 B	7.5	5.5	7.4	12.7	44.7	44.9	44.8	44.6	44.0	42.9	41.6	40.0	38.1	36.1	33.6	30.8	27.9	
MN 40-200 A	10	7.5	9.8	16.5	57.7	57.7	57.5	57.1	56.3	55.4	54.1	52.5	50.5	48.5	45.9	43.3	40.3	

MN 40-250

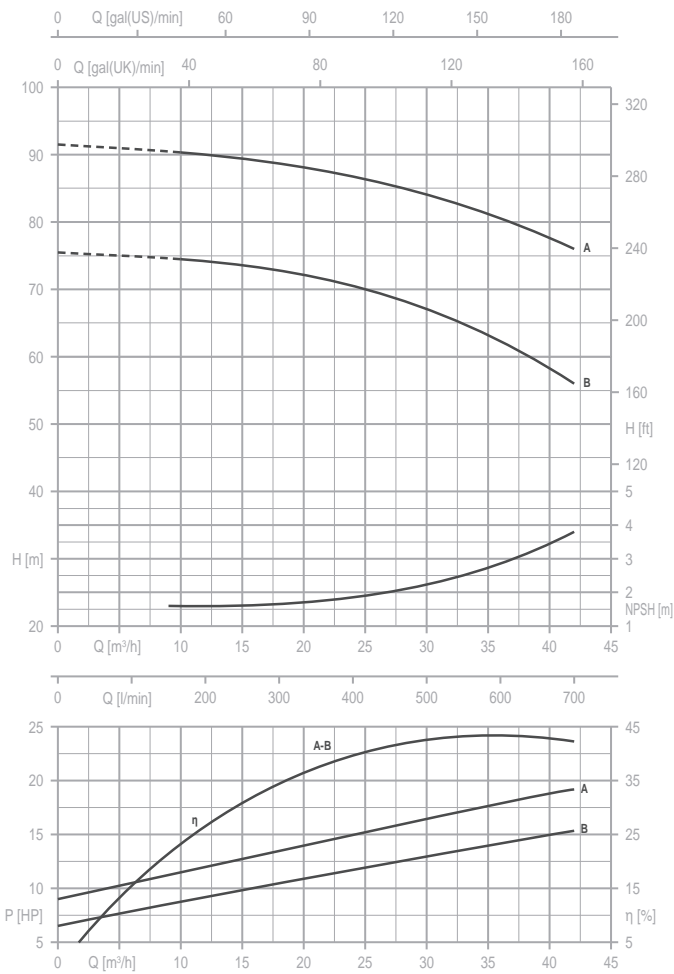

MN 50-125

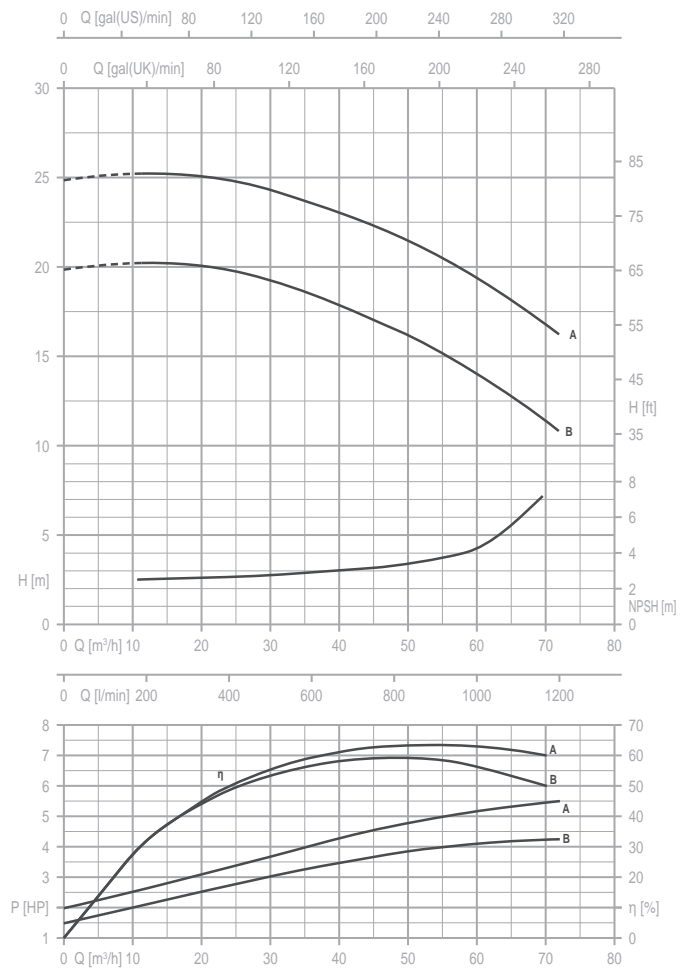

TYPE	P2		P1 (kW)	AMPERE	Q (m³/h - l/min)													
					3~	0	9	12	15	18	21	24	27	30	33	36	39	42
						0	150	200	250	300	350	400	450	500	550	600	650	700
	(HP)	(kW)	3~	3x400 V 50 Hz	H (m)													
MN 40-250 B	15	11.0	14.4	24.2	75.5	74,6	74,2	73,5	72,7	71,7	70,4	69	67,2	65	62,5	59,5	56	
MN 40-250 A	20	15	19.0	32.0	91.5	90,4	89,9	89,3	88,5	87,5	86,6	85,5	84	82,5	80,5	78,5	76	

TYPE	P2		P1 (kW)	AMPERE	Q (m³/h - l/min)																	
					3~	0	12	15	18	21	24	27	30	33	36	39	42	48	54	60	66	72
						0	200	250	300	350	400	450	500	550	600	650	700	800	900	1000	1100	1200
	(HP)	(kW)	3~	3x400 V 50 Hz	H (m)																	
MN 50-125 B	4	3	4,25	7,1	19,8	20,2	20,2	20,1	20	19,8	19,5	19,3	18,8	18,5	18	17,6	16,5	15,3	14	12,5	10,8	
MN 50-125 A	5,5	4	5,5	9,6	24,8	25,2	25,2	25,1	25	24,8	24,6	24,3	23,9	23,5	23,2	22,7	21,8	20,7	19,4	17,9	16,2	

MN 50-160

MN 50-200

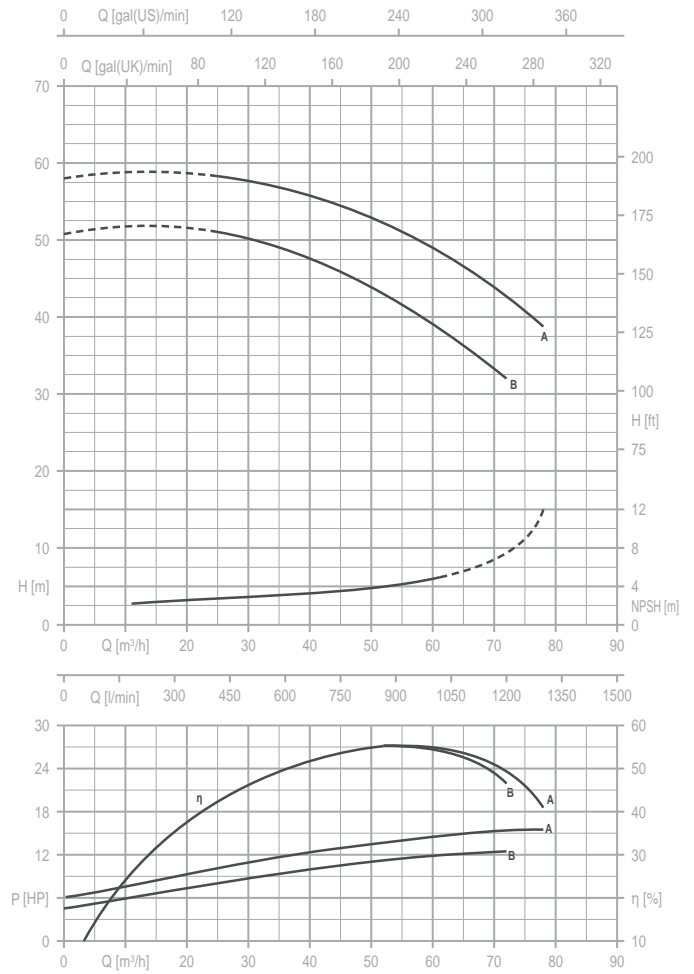
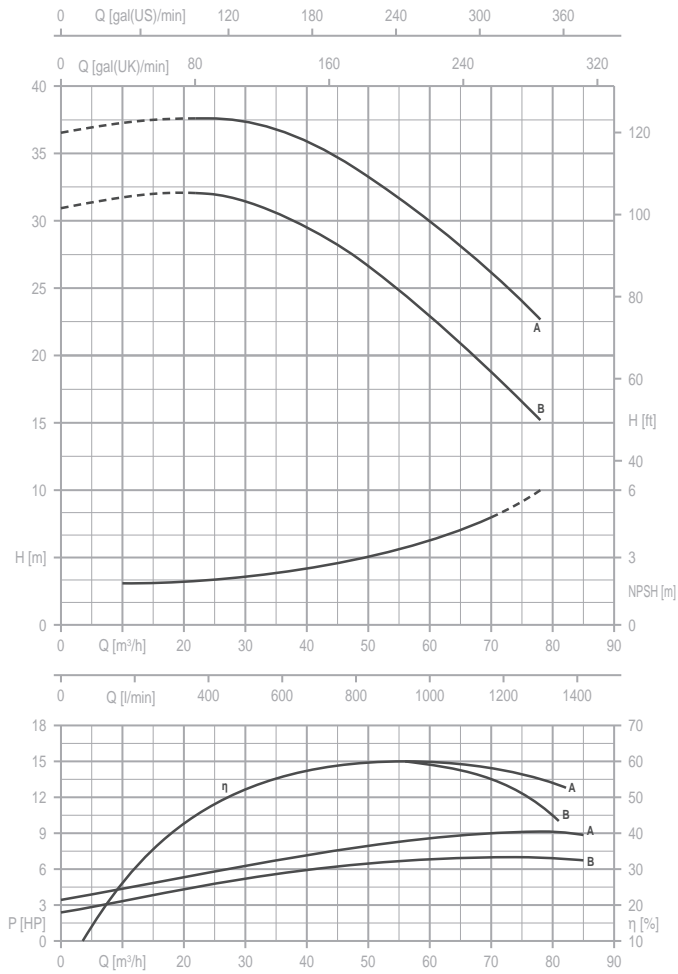

TYPE	P2		P1 (kW)	AMPERE	Q (m³/h - l/min)																
					3~	H (m)															
						0	21	24	27	30	33	36	39	42	48	54	60	66	72	78	
3~	(HP)	(kW)	3~	3~	0	350	400	450	500	550	600	650	700	800	900	1000	1100	1200	1300		
MN 50-160 B	7.5	5.5	6.7	11.6	31,1	32,1	32	31,7	31,4	31	30,4	29,7	28,9	27,3	25,3	23,1	20,7	18	15,2		
MN 50-160 A	10	7.5	9.4	15.8	36,7	37,9	37,8	37,7	37,4	37,1	36,6	36,1	35,4	33,9	32,1	30	27,8	25,3	22,6		

TYPE	P2		P1 (kW)	AMPERE	Q (m³/h - l/min)																
					3~	H (m)															
						0	24	27	30	33	36	39	42	48	54	60	66	72	78		
3~	(HP)	(kW)	3~	3~	0	400	450	500	550	600	650	700	800	900	1000	1100	1200	1300			
MN 50-200 B	15	11	12.4	21.0	50,8	51	50,5	50	49,3	48,5	47,7	46,8	44,7	42,2	39,5	35,9	32	-			
MN 50-200 A	20	15	15.4	27.0	58	58,3	58	57,5	57	56,4	55,7	55	53,2	51,3	49	46,3	42,8	38,8			

MN 50-250

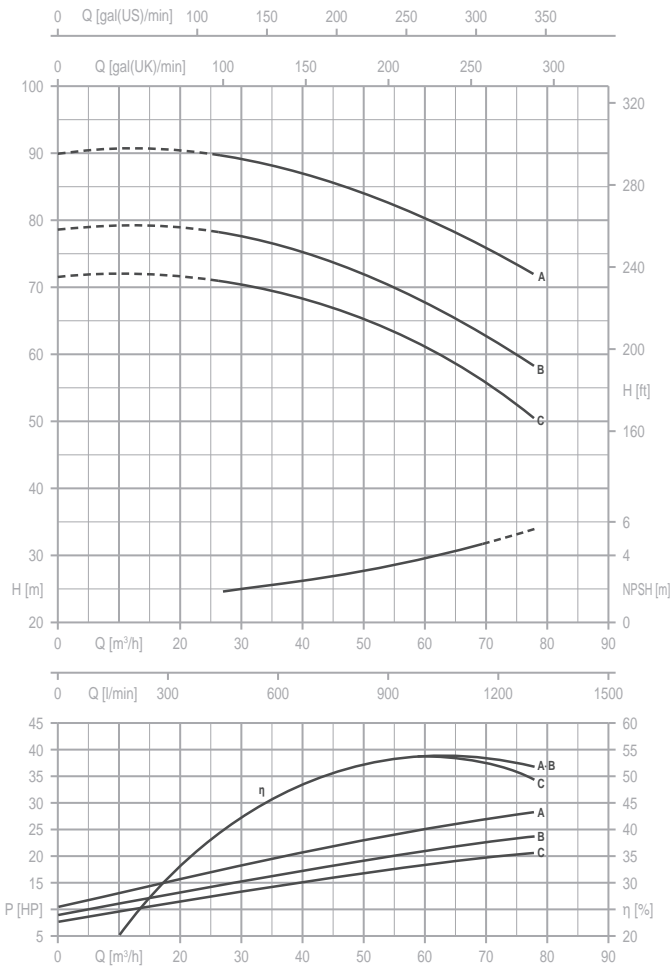

MN 65-125

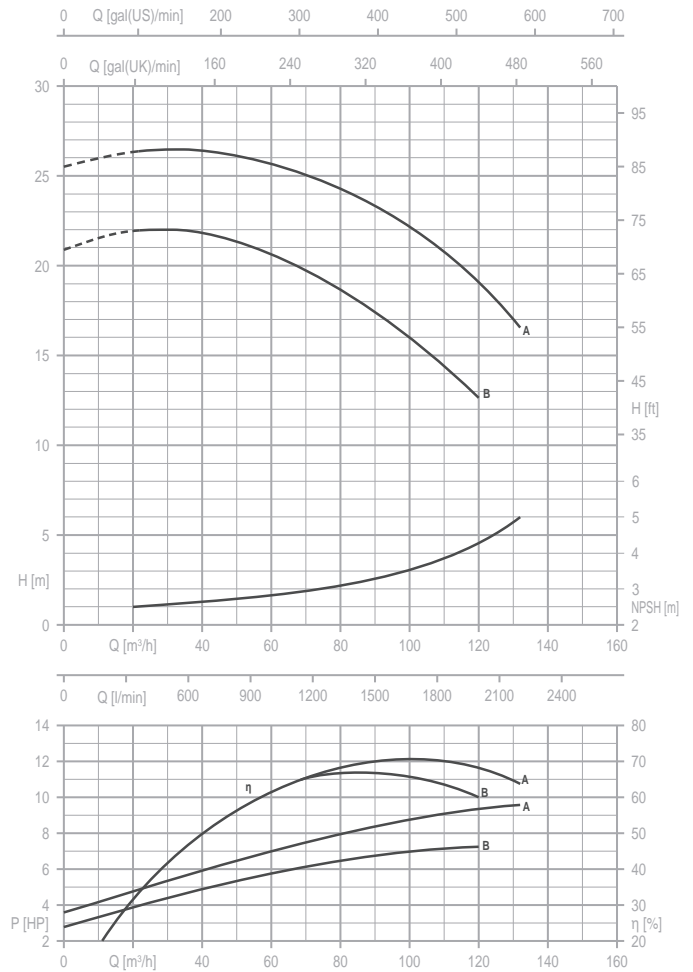

TYPE	P2		P1 (kW)	AMPERE	Q (m³/h - l/min)																
					3~	H (m)															
						0	27	30	33	36	39	42	48	54	60	66	72	78			
3~	(HP)	(kW)	3~	3~	0	450	500	550	600	650	700	800	900	1000	1100	1200	1300				
MN 50-250 C	20	15	20	32.5	71.5	70,8	70,3	69,7	69	68,3	67,6	66	64	61,5	58,6	55	50,5				
MN 50-250 B	25	18.5	23	41.5	78.0	78	77,4	76,8	76,1	75,3	74,5	72,8	70,6	68,2	65,5	62,2	58,3				
MN 50-250 A	30	22.5	28.5	51.5	90	89,5	88,8	88,3	87,7	86,9	86,1	84,5	82,7	80,5	78	75,2	71,7				

TYPE	P2		P1 (kW)	AMPERE	Q (m³/h - l/min)																		
					3~	H (m)																	
						0	30	33	36	39	42	48	54	60	66	72	78	84	96	108	120	132	
3~	(HP)	(kW)	3~	3~	0	500	550	600	650	700	800	900	1000	1100	1200	1300	1400	1600	1800	2000	2200		
MN 65-125 B	7.5	5.5	7.2	12.6	20,9	22	22	21,9	21,8	21,7	21,4	21	20,6	20,1	19,6	19	18,3	16,6	14,7	12,6	-		
MN 65-125 A	10	7.5	9.5	16.3	25,4	26,4	26,4	26,4	26,3	26,3	26,1	25,9	25,6	25,3	24,9	24,5	24	22,7	21	18,9	16,5		

MN 65-160

MN 65-200

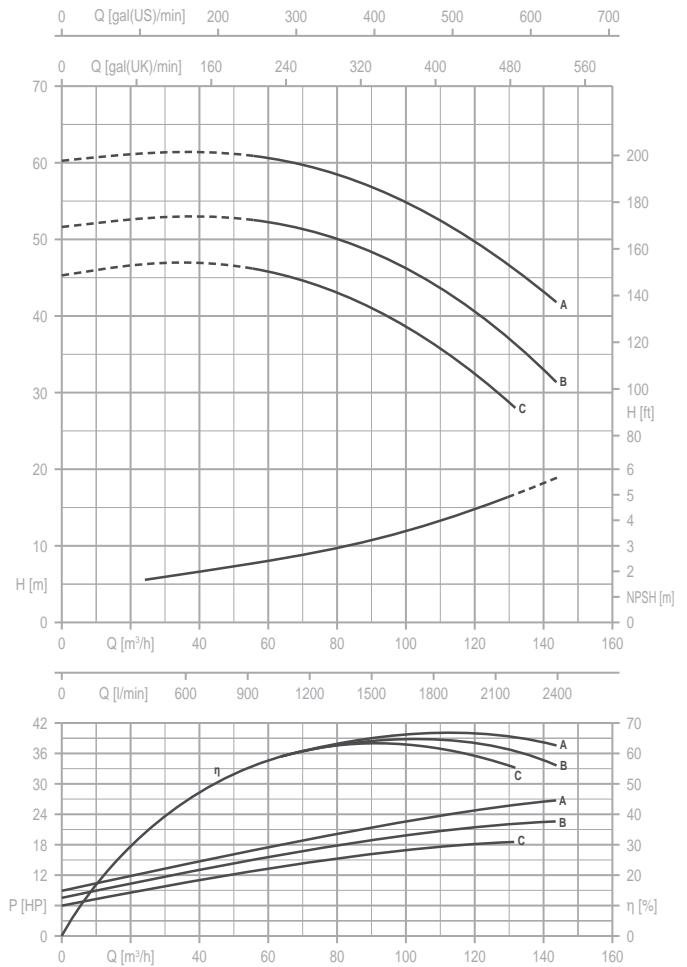
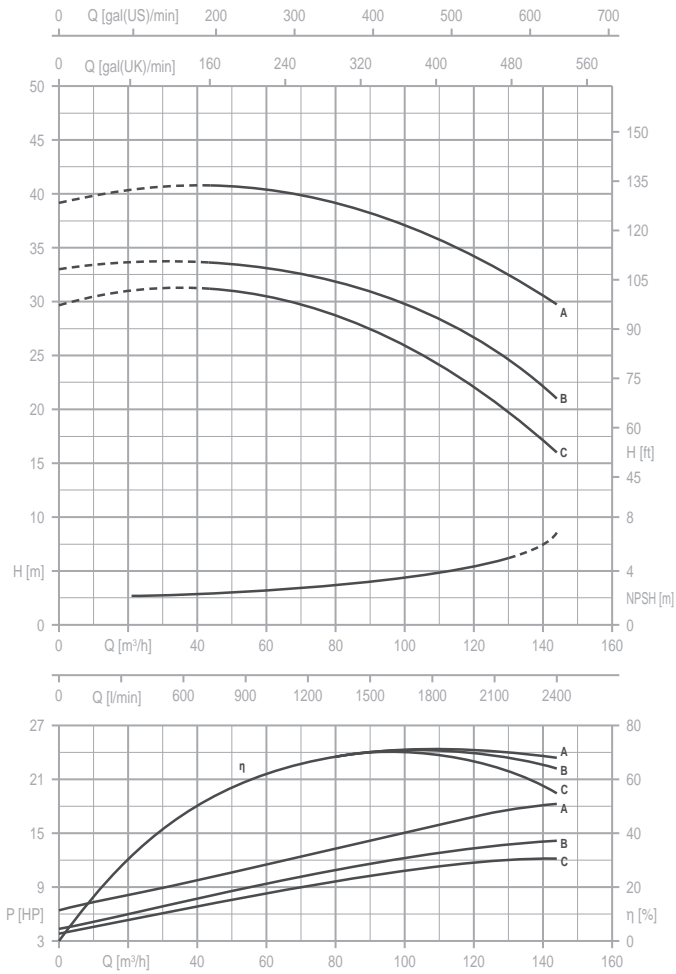

TYPE	P2		P1 (kW)	AMPERE	Q (m³/h - l/min)															
					3~	0	42	48	54	60	66	72	78	84	96	108	120	132	144	
						0	700	800	900	1000	1100	1200	1300	1400	1600	1800	2000	2200	2400	
3~	(HP)	(kW)	3~	3x400 V 50 Hz	H (m)															
MN 65-160 C	12.5	9.2	11.7	19.5	29,8	31,2	31,1	30,8	30,5	30,1	29,6	29	28,3	26,6	24,6	22,1	19,3	16		
MN 65-160 B	15	11	13	22.5	33	34,6	34,4	34,2	34	33,7	33,3	32,8	32,1	30,6	28,8	26,7	24,1	21,1		
MN 65-160 A	20	15	18	30.0	39,2	40,6	40,6	40,4	40,2	40	39,7	39,4	38,9	37,7	36,2	34,3	32,2	29,8		

TYPE	P2		P1 (kW)	AMPERE	Q (m³/h - l/min)															
					3~	0	54	60	66	72	78	84	96	108	120	132	144			
						0	900	1000	1100	1200	1300	1400	1600	1800	2000	2200	2400			
3~	(HP)	(kW)	3~	3x400 V 50 Hz	H (m)															
MN 65-200 C	20	15	18.6	31.4	45.3	46.3	45.7	45.1	44.3	43.4	42.3	39.8	36.7	32.7	28.0	-	-	-		
MN 65-200 B	25	18.5	22.6	38.2	51.6	52.6	52.2	51.8	51.0	50.2	49.3	47.1	44.1	40.9	36.6	31.3	-	-		
MN 65-200 A	30	22.5	26.6	43.8	60.2	61.0	60.6	60.1	59.5	58.7	57.8	55.8	53.1	49.8	46.1	41.7	-	-		

MN 80-160

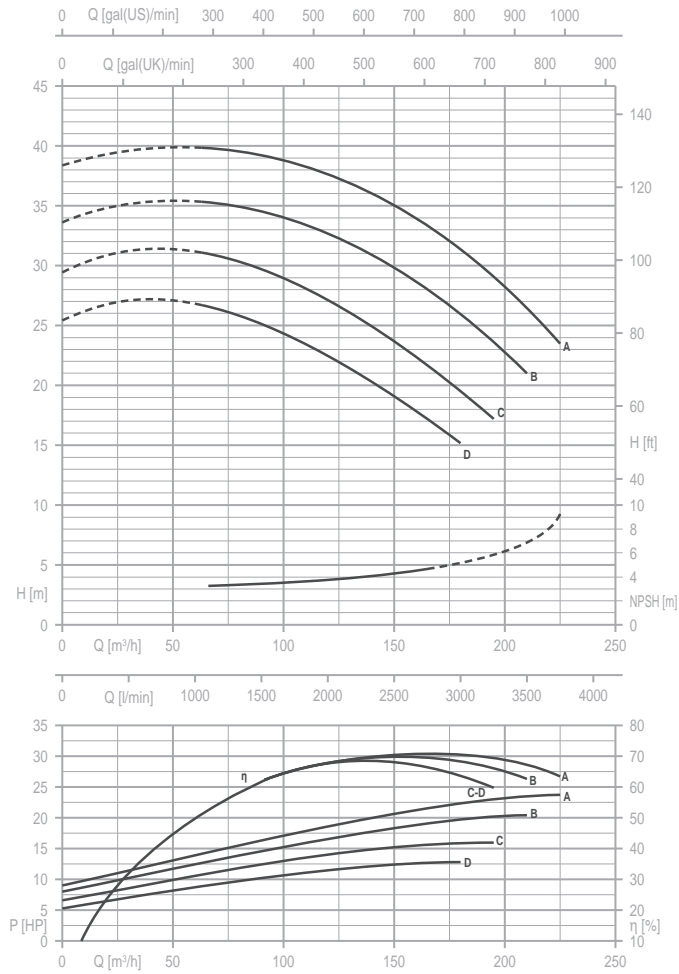

TYPE	P2		P1 (kW)	AMPERE		Q (m³/h - l/min)																
				3~	3~	H (m)																
						0	66	72	78	84	96	108	120	132	144	156	168	180	195	210	225	
3~	(HP)	(kW)	3~	3x400 V 50 Hz	0	1100	1200	1300	1400	1600	1800	2000	2200	2400	2600	2800	3000	3250	3500	3750		
MN 80-160 D	15	11	12.7	22.1	25,4	26,4	26,1	25,7	25,3	24,4	23,6	22,5	21,3	20	18,5	16,9	15,1	-	-	-		
MN 80-160 C	20	15	15.9	27.4	29,7	30,7	30,5	30,3	29,9	29,2	28,1	27,1	26	24,7	23,1	21,5	19,7	17,2	-	-		
MN 80-160 B	25	18.5	20.1	34.8	34	35	35	34,8	34,6	34	33,3	32,5	31,6	30,5	29,2	27,8	26	23,6	21	-		
MN 80-160 A	30	22.5	23.7	39.8	38,8	39,8	39,7	39,6	39,4	38,9	38,2	37,5	36,7	35,7	34,5	33,2	31,6	29,4	26,8	23,5		

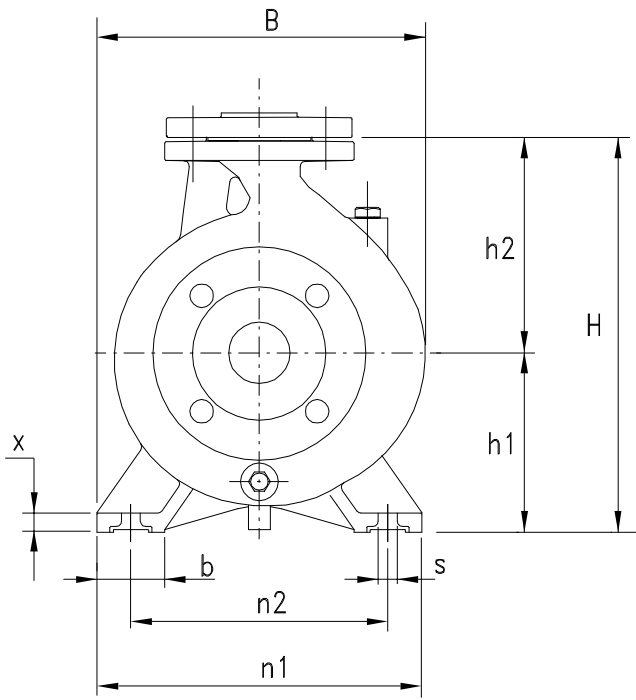

DIMENSIONS (mm)				
DN	D	K	holes	
			n°	Ø
32	140	100	4	18
40	150	110	4	18
50	165	125	4	18
65	185	145	4	18
80	200	160	8	18
100	220	180	8	18

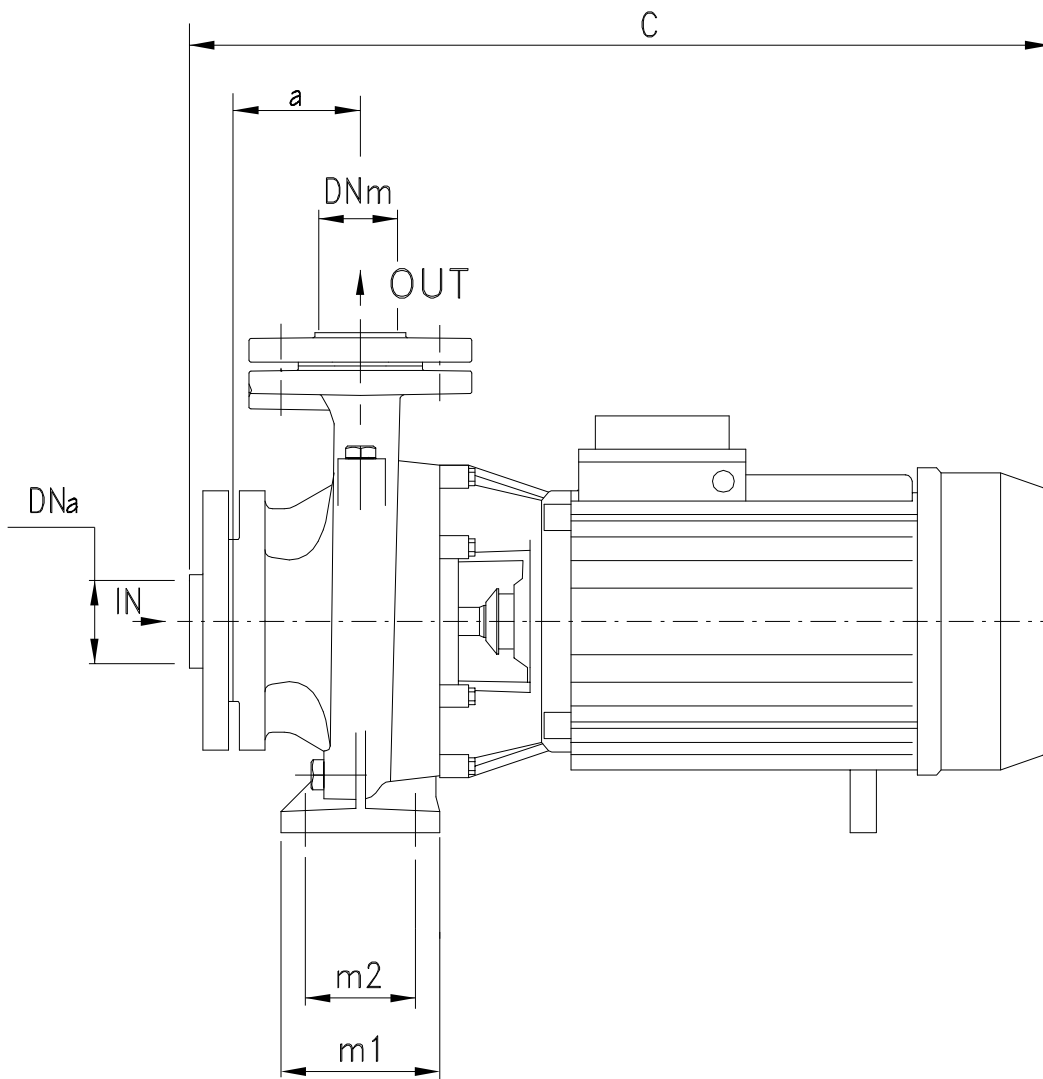
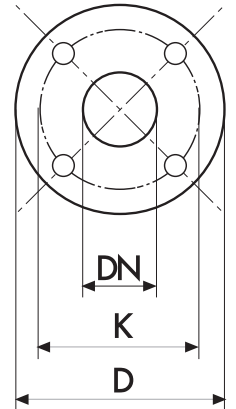

TYPE	DIMENSIONS (mm)																		Kg
	DNa	DNm	a	h1	h2	m1	m2	n1	n2	b	x	s	C	B	H	I	L	M	
32-160 C	50	32	80	132	160	100	70	240	190	50	12	14	490	240	292	520	260	355	38
32-160 B	50	32	80	132	160	100	70	240	190	50	12	14	490	240	292	520	260	355	39
32-160 A	50	32	80	132	160	100	70	240	190	50	12	14	490	240	292	520	260	355	42
32-200 C	50	32	80	160	180	100	70	240	190	50	12	14	505	268	340	530	305	400	51.5
32-200 B1	50	32	80	160	180	100	70	240	190	50	12	14	520	268	340	615	310	460	61
32-200 B	50	32	80	160	180	100	70	240	190	50	12	14	565	268	340	615	310	460	63
32-200 A1	50	32	80	160	180	100	70	240	190	50	12	14	520	268	340	615	310	460	67
32-200 A	50	32	80	160	180	100	70	240	190	50	12	14	565	268	340	615	310	460	69
32-250 C	50	32	100	180	225	125	95	320	250	65	12	14	625	305	405	665	335	535	83
32-250 B	50	32	100	180	225	125	95	320	250	65	14	14	625	305	405	665	335	535	90
32-250 A1	50	32	100	180	225	125	95	320	250	65	14	14	625	305	405	665	335	535	95
32-250 A	50	32	100	180	225	125	95	320	250	65	14	14	695	305	405	735	355	535	120
40-125 C	65	40	80	112	140	100	70	210	160	50	12	14	495	220	252	520	260	355	36
40-125 B	65	40	80	112	140	100	70	210	160	50	12	14	495	220	252	520	260	355	37
40-125 A	65	40	80	112	140	100	70	210	160	50	12	14	495	220	252	520	260	355	40
40-160 B	65	40	80	132	160	100	70	240	190	50	12	14	500	245	292	520	260	355	47
40-160 A	65	40	80	132	160	100	70	240	190	50	15	14	500	245	292	520	260	355	50
40-200 B1	65	40	100	160	180	100	70	240	190	50	15	14	545	273	340	615	310	460	63
40-200 B	65	40	100	160	180	100	70	265	212	50	15	14	590	273	340	615	310	460	65
40-200 A1	65	40	100	160	180	100	70	240	190	50	15	14	545	273	340	615	310	460	69
40-200 A	65	40	100	160	180	100	70	265	212	50	15	14	590	273	340	615	310	460	71
40-250 C	65	40	100	180	225	125	95	320	250	65	15	14	630	322	405	665	335	535	84
40-250 B	65	40	100	180	225	125	95	320	250	65	15	14	630	322	405	665	335	535	91
40-250 A1	65	40	100	180	225	125	95	320	250	65	15	14	630	322	405	665	335	535	96
40-250 A	65	40	100	180	225	125	95	320	250	65	15	14	700	322	405	735	355	535	121
40-250 BM	65	40	100	180	225	125	95	320	250	65	14	14	750	332	405	815	355	535	140
40-250 AM	65	40	100	180	225	125	95	320	250	65	14	14	750	332	405	815	355	535	149
50-125 B	65	50	100	132	160	100	70	240	190	50	12	14	525	250	292	520	260	355	47
50-125 A	65	50	100	132	160	100	70	240	190	50	12	14	525	250	292	520	260	355	50
50-160 B1	65	50	100	160	180	100	70	265	212	50	12	14	545	270	340	615	310	460	63
50-160 B	65	50	100	160	180	100	70	265	212	50	12	14	590	270	340	615	310	460	65
50-160 A1	65	50	100	160	180	100	70	265	212	50	12	14	545	270	340	615	310	460	69
50-160 A	65	50	100	160	180	100	70	265	212	50	12	14	590	270	340	615	310	460	71
50-200 C	65	50	100	160	200	100	70	265	212	50	12	14	635	290	360	665	335	535	82
50-200 B	65	50	100	160	200	100	70	265	212	50	12	14	635	290	360	665	335	535	89
50-200 A1	65	50	100	160	200	100	70	265	212	50	12	14	635	290	360	665	335	535	94
50-200 A	65	50	100	160	200	100	70	265	212	50	12	14	705	290	360	735	355	535	122
50-250 C	65	50	100	180	225	125	95	320	250	65	14	14	705	332	405	735	355	535	125
50-250 B	65	50	100	180	225	125	95	320	250	65	14	14	750	332	405	815	355	535	140
50-250 A	65	50	100	180	225	125	95	320	250	65	14	14	750	332	405	815	355	535	149
65-125 B1	80	65	100	160	180	125	95	280	212	65	14	14	560	280	340	615	310	460	62
65-125 B	80	65	100	160	180	125	95	280	212	65	14	14	605	280	340	615	310	460	64
65-125 A1	80	65	100	160	180	125	95	280	212	65	14	14	560	280	340	615	310	460	68
65-125 A	80	65	100	160	180	125	95	280	212	65	14	14	605	280	340	615	310	460	70
65-160 C	80	65	100	160	200	125	95	280	212	65	14	14	635	290	360	665	335	535	84
65-160 B	80	65	100	160	200	125	95	280	212	65	14	14	635	290	360	665	335	535	90
65-160 A1	80	65	100	160	200	125	95	280	212	65	14	14	635	290	360	665	355	535	95
65-160 A	80	65	100	160	200	125	95	280	212	65	14	14	705	290	360	735	355	535	120
65-200 C1	80	65	100	180	225	125	95	320	250	65	14	14	675	330	405	735	355	535	92
65-200 C	80	65	100	180	225	125	95	320	250	65	14	14	705	330	405	735	355	535	122
65-200 B	80	65	100	180	225	125	95	320	250	65	14	14	750	330	405	815	355	535	138
65-200 A	80	65	100	180	225	125	95	320	250	65	14	14	750	330	405	815	355	535	148
65-250 B	80	65	100	200	250	160	120	360	280	80	16	19	820	370	450	850	380	490	194
65-250 A	80	65	100	200	250	160	120	360	280	80	16	19	820	370	450	850	380	490	214
80-160 E	100	80	125	180	225	125	95	320	250	65	14	14	665	330	405	665	335	535	92
80-160 D	100	80	125	180	225	125	95	320	250	65	14	14	665	330	405	665	335	535	98.5
80-160 C1	100	80	125	180	225	125	95	320	250	65	14	14	665	330	405	665	335	535	104
80-160 C	100	80	125	180	225	125	95	320	250	65	14	14	735	330	405	735	355	535	129
80-160 B	100	80	125	180	225	125	95	320	250	65	14	14	780	330	405	815	355	535	143
80-160 A	100	80	125	180	225	125	95	320	250	65	14	14	780	330	405	815	355	535	152