

KDN

STANDARDISED CENTRIFUGAL PUMPS

BARE SHAFT

ON BEDPLATE WITH MOTOR AND COUPLING



GENERAL DATA

Applications

Enbloc, centrifugal motor-driven pumps with coupling designed for a wide range of applications such as:

- supplying water
- the circulation of hot water for central heating
- the circulation of cold water for air conditioning and refrigerating
- the transfer of liquids in agriculture, horticulture and in industries
- the implementation of pumping systems

These pumps can be coupled with elastic coupling (standard or spacer) to a 2 or 4 poles electric motor and mounted on a pressed sheet base complying with UNI EN 23661.

Constructional features of the pump

Single-stage, cast iron spiral body made to DIN-EN 733 (formerly DIN 24255), seal holder cover and support in cast iron, flanges made to DIN 2533 and DIN 2532 for DN 200.

Impeller in cast iron, encased and dynamically balanced with compensation of the axial thrust by means of balancing holes, operating (on request) with interchangeable wear rings.

Stainless steel pump shaft supported by two large maintenance-free greased ball bearings, greased for life and housed inside a special chamber of the support.

Standard seal: standardised mechanical seal made to DIN 24960 in carbon/carborundum with O' rings in EPDM.

Packing with lubricating hydraulic ring and stuffing box in two easily removable parts, available on request.

TECHNICAL DATA

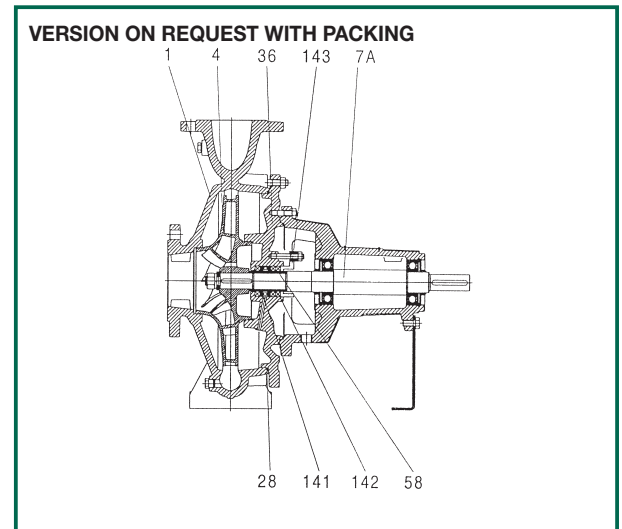
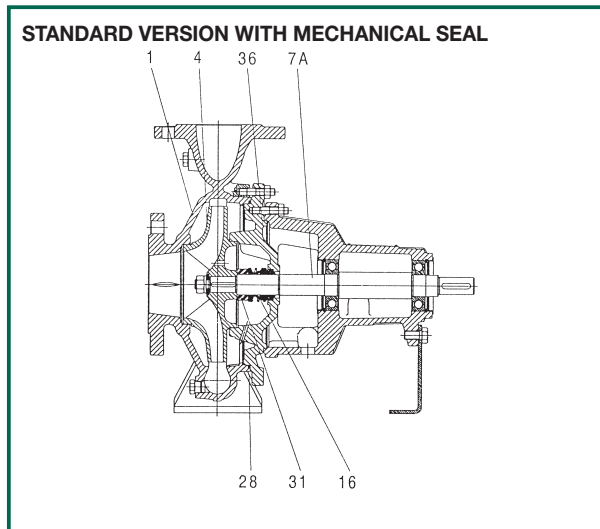

STANDARD VERSION WITH MECHANICAL SEAL

N.	PARTS	MATERIALS
1	PUMP BODY	CAST IRON 250 UNI ISO 185
4	IMPELLER	CAST IRON 250 UNI ISO 185
7A	PUMP SHAFT	STAINLESS STEEL AISI 420 - UNI 6900/71
28	GASKET OR	VITON
36	SEAL HOLDER DISK	CAST IRON 250 UNI ISO 185
16	MECHANICAL SEAL	CARBON/CARBORUNDUM
31	SPACER SEAL	STAINLESS STEEL AISI 304 - UNI 6900/71

VERSION ON REQUEST WITH PACKING

N.	PARTS	MATERIALS
58	BUSH FOR SEAL	STAINLESS STEEL AISI 420 - UNI 6900/71
141	HYDRAULIC RING	STAINLESS STEEL AISI 304 - UNI 6900/71
142	PACKING	PTFE IMPREGNATED RAMIE

- Rotation speed: 1450 - 2900 1/min.
- Operating range: from 1 to 500 m³/h with a head of up to 100 m.
- Pumped liquid: without solid or abrasive substances, not viscous, not aggressive, not crystallised and chemically neutral, close to water characteristics.
- Liquid temperature range: from -10°C to +140°C.
- Maximum ambient temperature: +40°C.
- Maximum working pressure: 16 bar - 1600 kPa (for DN 200 max 10 bar).
- Flanging: PN 16 DIN 2533
PN 10 DIN 2532 per DN 200
- Installation: normally horizontal.
- Special version on request: pumps for liquids other than water.
Packing (that can also be fed externally).
Other voltages and/or frequencies.

Description of the product

In the description of the bare shaft pump no mention is made of the coupling or motor data.

In the description of the pumps mounted on a base without a motor, the motor's data are not mentioned.

The example given describes an NK 100-200 type pump with a cast iron 198 Ø impeller, with BAQE type mechanics, standard coupling and 4-poles 5.5 kW motor running on 380-415 V 50 Hz.

Example		KDN 100 - 200 / 198 A W / BAQE / 1 / 5,5 / 4	
Type	_____	_____	_____
Nominal diameter of discharge port (DN)	_____	_____	_____
Nominal diameter of the impeller	_____	_____	_____
Actual diameter of the impeller	_____	_____	_____
Material codes:			
A (01): Cast iron	_____	_____	_____
B (03): Cast iron with bronze impeller	_____	_____	_____
Wear rings (only when existing)	_____	_____	_____
Seal code	_____	_____	_____
Type of pump/motor coupling			
0 = Without coupling (bare shaft pump)	_____	_____	_____
1 = With elastic standard coupling	_____	_____	_____
2 = With elastic spacer coupling	_____	_____	_____
Motor power in kW	_____	_____	_____
Voltage and number of motor poles	_____	_____	_____

Pump material codes

Component	Version	
	A (01) cast iron	B (03) cast iron with bronze impeller
Pump body	GG25	GG25
Seal holder disk	GG25	GG25
Stuffing box	OT Cu 62 Si1	OT Cu 62 Si1
Impeller	GG25	GCuSn5Zn5Pb5 UNI 7013/8a-72
Consumable rings*	GG20	GG20
Pump shaft	AISI 420 UNI 6900/71	
Shaft sleeve**	AISI 420 UNI 6900/71	

Packing codes

Item	Code	Description of the packing
1	S	Stuffing box type
Item	Code	Cooling
2	N	Stuffing box not cooled
	K	Stuffing box cooled
Item	Code	Sealing liquid
3	E	With internal liquid
	F	With external liquid
	O	Without hydraulic ring

Description of the mechanical seal

Item	Code	Description of the seal
1	A	O ring with fixed guide
	B	Rubber bellows seal
	C	O ring with spring guide
	D	Balanced O ring
	M	Metal bellows seal
	X	Other seal types
Item	Code	Materials
2 & 3	A	Impregnated carbon/metal
	B	Impregnated carbon/resin
	C	Other carbon types
	S	Chromium steel
	U	Tungsten carbide
	Q	Carborundum
	V	Aluminium oxide (ceramic)
X	Other ceramic types	
Item	Code	Materials
4	P	Nitrile rubber (NBR)
	S	Silicone rubber
	T	Teflon (PTFE)
	E	EPDM
	V	Viton
	M	PTFE coated O ring
Item	Code	Materials
5	v	Reinforced

* on request

** only for packing or balanced mechanical seal

Description of the product code

Impeller's nominal diameter	Code
125	1
160	2
200	3
250	4
315	5
125.1	K
160.1	L
200.1	M

Pump type	Code
KDN 32	1
KDN 40	2
KDN 50	3
KDN 65	4
KDN 80	5
KDN 100	6
KDN 125	7
KDN 150	8

Identification	Code
DAB PUMPS S.p.A.	D

	Code
DAB PUMPS S.p.A.	1

Code	Pump/impeller materials
1	A (01) = cast iron/cast iron
2	B (03) = cast iron/bronze
3	
4	
5	A (01) + Wr*
6	B (03) + Wr*
7	
8	

* With consumable rings

Code	Seal available
1	BAQE
2	BAQE-RMG12
5	BQQV*
7	BAQV*
A	SNE*
B	SNO*
C	SNF*
G	BQQE*

* On request

Code	Coupling
0	Without coupling*
1	With elastic standard coupling
2	With elastic spacer coupling

* Bare shaft pump

Code	P2 nominal kW
0	Bare shaft
1	0,37
2	0,55
3	0,75
4	1,1
5	1,5
6	2,2
7	3
8	4
9	5,5
A	7,5
B	11
C	15
D	18,5
E	22
F	30
G	37
H	45
K	55
L	75
M	90
N	110
P	132

Product code

1	D	1	1	1	1	1	1	1
---	---	---	---	---	---	---	---	---

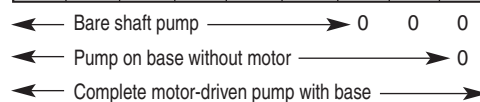

Code	Voltage	Poles
0	Without motor	
1	3x220-240 / 380-415V 50 Hz 3x220-265 / 380-460V 60 Hz	2
2	3x380-415 50 Hz 3x380-460V 60 Hz	2
3	3x220-240 / 380-415V 50 Hz 3x220-265 / 380-460V 60 Hz	4
4	3x380-415 50 Hz 3x380-460V 60 Hz	4
5	3x380-415V 50 Hz (with inverter)	2
6	3x380-415V 50 Hz (with inverter)	4

GENERAL DATA

STANDARDIZED MOTOR-DRIVEN PUMPS ON BASEPLATE

Asynchronous, closed and cooled with external ventilation, 2 or 4 poles. Rotor mounted on extra large ball bearings to guarantee low noise running and durability.
 Electrical protection: in compliance with the EEC 89/336 ELECTROMAGNETIC COMPATIBILITY directive and subsequent amendments, EEC 73/23 LOW VOLTAGE directive and subsequent amendments and CEI 2-3 standards.

Construction:

Protection level: IP 55

Insulation class: F

Supply voltage: Three-phase 230-400V 50 Hz up to 2,2 kW inclusive
 400V \varnothing 50 Hz over 2,2 Kw

Special versions on request: other voltages and/or frequencies.

Instruction to find the pump and motor required

1. Find on the chart supplied the family of pumps that offer, more or less, the rates of flow and heads required.

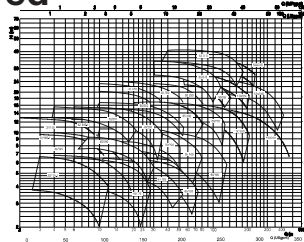

2. Look for the most suitable characteristic on the characteristic curves of each family.

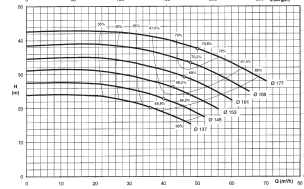

3. Find the power wanted on the power graph for the pump to work where it is wanted.

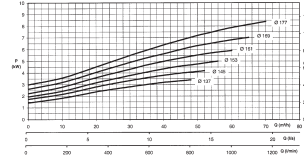

4. There are likely to be variations in the rate of flow of the liquid pumped causing an oscillation of the functioning point, in which case the power absorbed could be greater. When choosing the motor, allow the following safety margins:

If necessary, adjust the power of the motor to be installed if you expect to be pumping liquids with quite high viscosity and specific weight values (verify suitability of construction materials in contact with the liquid).

5. With the name of the pump and the power of the motor, find on the following technical data the name of the most suitable base (with motor, spacer coupling and coupling cover).

6. The pump and base required will be delivered already assembled and aligned, although an alignment check is always required after installation (see INSTRUCTION MANUAL).

Dimensions of bare shaft pumps

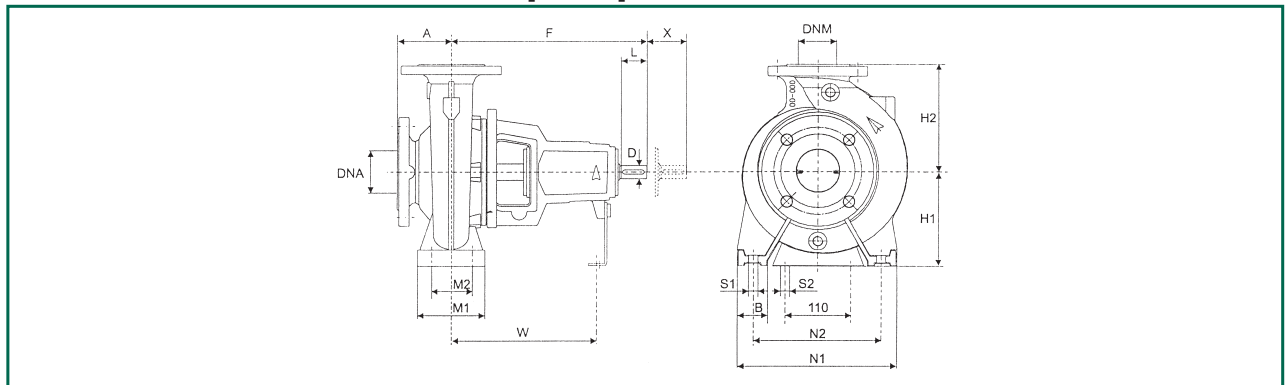

MODEL	η max 1450 min ⁻¹		η max 2900 min ⁻¹		Flange dimensions		Pump dimensions				Support dimensions					Holes for bolts		Shaft end		X	WEIGHT Kg										
	Q m ³ /h	H m	Q m ³ /h	H m	DNA	DNM	A	F	H1	H2	B	M1	M2	N1	N2	W	S1	S2	D			L									
KDN 32-125.1	10.5	5.5	20.9	22	50	32	80	360	112	140	50	100	70	190	140	260	M12	M12	24	50	100	37									
KDN 32-125	13.6	5.8	28	22.8					132	160												36									
KDN 32-160.1	8.7	8.3	17.5	33					240	190												38									
KDN 32-160	15.9	8.6	31	34					160	180												38									
KDN 32-200.1	8.5	11.4	18	45					180	200												46									
KDN 32-200	17.7	13.2	35.5	52.5					200	225												46									
KDN 40-125	21.8	5.6	46	21.5	65	40	80	360	112	140	50	100	70	210	160	260	M12	M12	24	50	100	39									
KDN 40-160	25.8	9.2	50	37.2					132	160				41																	
KDN 40-200	29	12.6	57	51					100	160				180	49																
KDN 40-250	31	19.1	62	77					180	225				57																	
KDN 50-125	41	5.4	83	21.5	65	50	100	360	132	160	50	100	70	240	190	260	M12	M12	24	50	100	42									
KDN 50-160	43.3	9.3	87.5	37					160	180				44																	
KDN 50-200	41	14	81	56					200	225				51																	
KDN 50-250	49	19.1	100	76					180	225				59																	
KDN 65-125	57	5.2	114	21	80	65	100	360	160	180	65	125	95	280	212	260	M12	M12	24	50	100	46									
KDN 65-160	61	8.6	121	34.5					200	225				47																	
KDN 65-200	62	14.8	123	59					180	225				66																	
KDN 65-250	65.4	20	129	81					470	200				250	80							160	120	360	280	340	M16	32	80	140	93
KDN 65-315	84	31.5	-	-					125	225				280	400							315	400	315	400	315	400	315	400	315	112
KDN 80-160	101	8.1	195	33.5					100	80				125	360							180	225	65	125	95	320	250	260	M12	M12
KDN 80-200	101	14.4	200	57.5	470	250	345	280			340	32	80			84															
KDN 80-250	103	23	215	88	200	280	80	160			120	400	315			M16	104														
KDN 80-315	136	35	-	-	250	315	122																								
KDN 100-200	163	13.4	315	53	125	100	125	470	200	280	80	160	120	360	280	340	M16	M12	32	80	140	96									
KDN 100-250	159	21.8	313	87					140	225				400	315							111									
KDN 100-315	187	34.1	-	-					250	315				126																	
KDN 125-250	289	20.5	-	-	150	125	140	470	250	355	80	160	120	400	315	340	M16	M12	32	80	140	135									
KDN 150-200	378	10	-	-	200	150	160	470	280	400	100	200	150	550	450	340	M20	M12	32	80	140	178									

The sizes 32-125.1, 32-160.1, 32-200.1 e 150-200 are supplementary sizes and not included in DIN-EN 733 (ex DIN 24255) standard.

	Nominal diameter (DN)									
	DIN 2533 PN 16									DIN 2532 PN 10
	32	40	50	65	80	100	125	150	200	
D₁	32	40	50	65	80	100	125	150	200	
D₂	100	110	125	145	160	180	210	240	295	
D₃	140	150	165	185	200	220	250	285	340	
S	18	18	18	18	18	18	18	22	22	
n° holes	4	4	4	4	8	8	8	8	8	

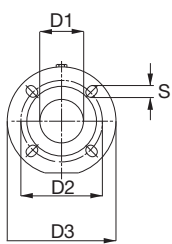

Dimensions and electrical data of a complete motor-driven pump

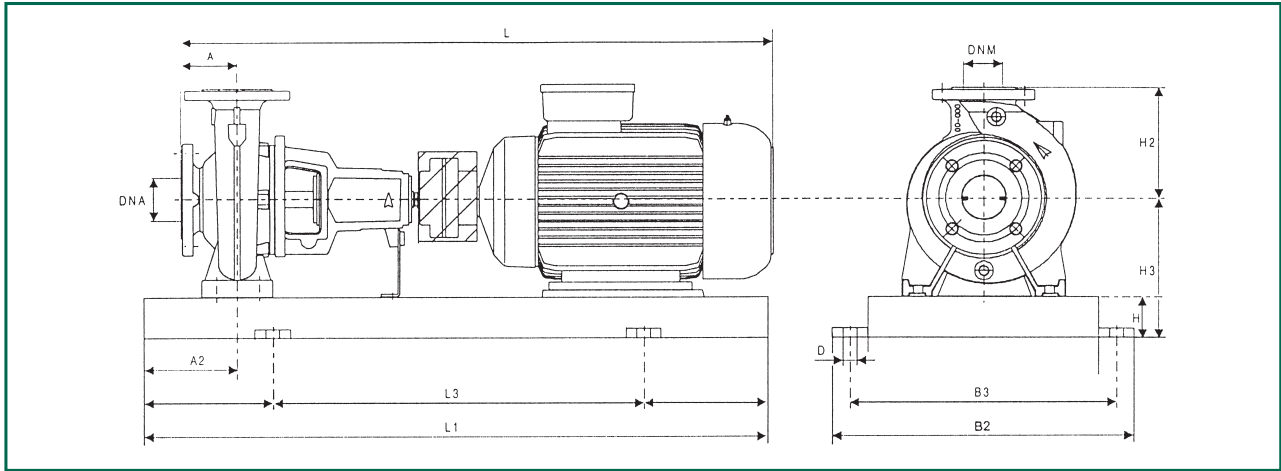

MODEL	Power (kW)		MOTOR SIZE	Supply voltage 50 Hz	I nom (A)	Flange dims. (mm)		Unit dimensions (mm)											Standard coupling		Spacer coupling		Ref.
	4 poles	2 poles				DNA	DNM	A	A2	H2	H	H3	L1	L3	B2	B3	D	L	Weight Kg	L	Weight Kg		
KDN 32-125.1	0.37	–	MEC 71	230/400V	1,7-0,975	50	32	80	60	140	65	177	800	540	360	320	19	694	81	794	86	2	
	0.55	–	MEC 80	230/400V	2,6-1,5													737	83	837	88	2	
	–	0.75	MEC 80	230/400V	2,88-1,66														85		89	2	
	–	1.1	MEC80	230/400V	4-2,3														86		90	2	
	–	1.5	MEC 90S	230/400V	5,75-3,3														789	93	889	91	3
	–	2.2	MEC 90L	230/400V	7,9-4,55								900	600	390	350			100		98	3	
	–	3	MEC 100L	400V Ø	5,9														826	102	936	105	3
	–	4	MEC 112M	400V Ø	7,8													846	102	946	107	3	
KDN 32-125	0.37	–	MEC 71	230/400V	1,7-0,975	50	32	80	60	140	65	177	800	540	360	320	19	694	81	794	86	2	
	0.55	–	MEC 80	230/400V	2,6-1,5													737	83	837	88	2	
	0.75	–	MEC 80	230/400V	3,3-1,9														84		89	2	
	–	1.1	MEC 80	230/400V	4-2,3														85		90	2	
	–	1.5	MEC 90S	230/400V	5,75-3,3														789	86	889	91	2
	–	2.2	MEC 90L	230/400V	7,9-4,55								900	600	390	350			93		98	3	
	–	3	MEC 100L	400V Ø	5,9														826	96,3	926	105	3
	–	4	MEC 112M	400V Ø	7,8													846	117	946	107	3	
KDN 32-160.1	0.37	–	MEC 71	230/400V	1,7-0,975	50	32	80	60	160	65	197	800	540	360	320	19	694	83	794	88	2	
	0.55	–	MEC 80	230/400V	2,6-1,5													737	86	837	90	2	
	0.75	–	MEC 80	230/400V	3,3-1,9														86		91	2	
	–	1.1	MEC 80	230/400V	4-2,3														91		96	2	
	–	1.5	MEC 90S	230/400V	5,75-3,3														789	94	889	99	2
	–	2.2	MEC 90L	230/400V	7,9-4,55								900	600	390	350			102		100	3	
	–	3	MEC 100L	400V Ø	5,9														826	102	926	107	3
	–	4	MEC 112M	400V Ø	7,8													846	104	946	109	3	
	–	5.5	MEC 132S	400V Ø	10,2						80	212	1000	660	450	400	24	959	136	1059	141	4	
KDN 32-160	0.37	–	MEC 71	230/400V	1,7-0,975	50	32	80	60	160	65	197	800	540	360	320	19	694	83	794	88	2	
	0.55	–	MEC 80	230/400V	2,6-1,5													737	85	837	90	2	
	0.75	–	MEC 80	230/400V	3,3-1,9														86		91	2	
	1.1	–	MEC 90S	230/400V	4,35-2,5														789	88	889	93	2
	–	2.2	MEC 90L	230/400V	7,9-4,55								900	600	390	350			92		100	3	
	–	3	MEC 100L	400V Ø	5,9														826	102	926	107	3
	–	4	MEC 112M	400V Ø	7,8														846	104	946	109	3
	–	5.5	MEC 132S	400V Ø	10,2						80	212	1000	660	450	400	24	959	136	1059	141	4	
	–	7.5	MEC 132S	400V Ø	13,6													139		144	4		

Dimensions and electrical data of a complete motor-driven pump

MODEL	Power (kW)		MOTOR SIZE	Supply voltage 50 Hz	I nom (A)	Flange dims. (mm)		Unit dimensions (mm)										Standard coupling		Spacer coupling		REF.		
	4 poles	2 poles				DNA	DNM	A	A2	H2	H	H3	L1	L3	B2	B3	D	L	Weight Kg	L	Weight Kg			
KDN 32-200.1	0.37	-	MEC 71	230/400V	1,7-0,975	50	32	80	60	180	65	225	800	540	360	320	19	694	87	794	92	2		
	0.55	-	MEC 80	230/400V	2,6-1,5													737	89	837	94	2		
	0.75	-	MEC 80	230/400V	3,3-1,9														101			95	2	
	1.1	-	MEC 90S	230/400V	4,35-2,5														789	106	889	97	2	
	-	2.2	MEC 90L	230/400V	7,9-4,55								900	600	390	350				108			106	3
	-	3	MEC 100L	400V Ø	5,9														826	140	926	111	3	
	-	4	MEC 112M	400V Ø	7,8														846	143	946	113	3	
	-	5.5	MEC 132S	400V Ø	10,2						80	240	1000	660	450	400	24	959	143	1059	145	4		
	-	7.5	MEC 132S	400V Ø	13,6														166			148	4	
KDN 32-200	0.37	-	MEC 71	230/400V	1,7-0,975	50	32	80	60	180	65	225	800	540	360	320	19	846	87	794	92	2		
	0.55	-	MEC 80	230/400V	2,6-1,5														737	89	837	94	2	
	0.75	-	MEC 80	230/400V	3,3-1,9															90			95	2
	1.1	-	MEC 90S	230/400V	4,35-2,5														789	101	889	97	2	
	1.5	-	MEC 90L	230/400V	6-3,45								900	600	390	350				101			105	3
	2.2	-	MEC 100L	230/400V	7,95-4,6														826	102	926	109	3	
	-	3	MEC 100L	400V Ø	5,9															103			126	3
	-	4	MEC 112M	400V Ø	7,8														846	104	946	134	3	
	-	5.5	MEC 132S	400V Ø	10,2						80	240	1000	660	450	400	24	959	143	1059	145	4		
	-	7.5	MEC 132S	400V Ø	13,6															177			148	4
	-	11	MEC 160M	400V Ø	19,6								1120	740	490	440		1069	237	1169	172	5		
	-	15	MEC 160M	400V Ø	26,5															248			182	5
KDN 40-125	0.37	-	MEC 71	230/400V	1,7-0,975	65	40	80	60	140	65	177	800	540	360	320	19	694	81	794	86	2		
	0.55	-	MEC 80	230/400V	2,6-1,5														737	83	837	88	2	
	0.75	-	MEC 80	230/400V	3,3-1,9															84			89	2
	1.1	-	MEC 90S	230/400V	4,35-2,5														789	86	889	81	2	
	-	1.5	MEC 90S	230/400V	5,75-3,3															86			97	2
	-	2.2	MEC 90L	230/400V	7,9-4,55								900	600	390	350				91			100	3
	-	3	MEC 100L	400V Ø	5,9														826	91	926	105	3	
	-	4	MEC 112M	400V Ø	7,8														846	102	946	107	3	
	-	5.5	MEC 132S	400V Ø	10,2						80	212	1000	660	450	400	24	959	134	1059	139	4		
	-	7.5	MEC 132S	400V Ø	13,6														137			142	4	
KDN 40-160	0.37	-	MEC 71	230/400V	1,7-0,975	65	40	80	60	160	65	197	800	540	360	320	19	694	85	794	87	2		
	0.55	-	MEC 80	230/400V	2,6-1,5														737	89	837	90	2	
	0.75	-	MEC 80	230/400V	3,3-1,9															89			91	2
	1.1	-	MEC 90S	230/400V	4,35-2,5														789	91	889	93	2	
	1.5	-	MEC 90L	230/400V	6-3,45								900	600	390	350				101			101	3
	-	3	MEC 100L	400V Ø	5,9														826	102	926	106	3	
	-	4	MEC 112M	400V Ø	7,8														846	104	946	109	3	
	-	5.5	MEC 132S	400V Ø	10,2						80	212	1000	660	450	400	24	959	160	1059	141	4		
	-	7.5	MEC 132S	400V Ø	13,6															165			144	4
	-	11	MEC 160M	400V Ø	19,6								240	1120	740	490	440	1069	173	1169	168	5		
	-	15	MEC 160M	400V Ø	26,5															173			178	5
	KDN 40-200	0.55	-	MEC 80	230/400V	2,6-1,5	65	40	100	60	180	65	225	900	600	390	350	19	757	98	857	103	3	
0.75		-	MEC 80	230/400V	3,3-1,9															98			106	3
1.1		-	MEC 90S	230/400	4,35-2,5														809	101	909	109	3	
1.5		-	MEC 90L	230/400V	6-3,45															105			113	3
2.2		-	MEC 100L	230/400V	7,95-4,6														846	111	946	116	3	
3		-	MEC 100L	400V Ø	6,7															118			120	3
-		4	MEC 112M	400V Ø	7,8														869	135	969	140	3	
-		5.5	MEC 132S	400V Ø	10,2						80	240	1000	660	450	400	24	979	146	1079	151	4		
-		7.5	MEC 132S	400V Ø	13,6															147			152	4
-		11	MEC 160M	400V Ø	19,6								1120	740	490	440		1089	221	1189	176	5		
-		15	MEC 160M	400V Ø	26,5															231			186	5
-		18.5	MEC 160L	400V Ø	33															1134	231	1234	208	5

MODEL	Power (kW)		MOTOR SIZE	Supply voltage 50 Hz	I nom (A)	Flange dimens. (mm)		Unit dimensions (mm)											Standard coupling		Spacer coupling		REF.
	4 poles	2 poles				DNA	DNM	A	A2	H2	H	H3	L1	L3	B2	B3	D	L	Weight Kg	L	Weight Kg		
KDN 40-250	1.5	-	MEC 90L	230/400V	6-3,45	65	40	100	75	225	80	260	1000	660	450	400	24	809	125	909	130	4	
	2.2	-	MEC 100L	230/400V	7,95-4,6													846	129	946	134	4	
	3	-	MEC 100L	400V Ø	6,7														149		137	4	
	4	-	MEC 112M	400V Ø	8,1													869	200	969	141	4	
	-	11	MEC 160M	400V Ø	19,6								1250	840	540	490		1089	236	1189	231	6	
	-	15	MEC 160M	400V Ø	26,5														278		234	6	
	-	18.5	MEC 160L	400V Ø	33													1134	298	1234	236	6	
	-	22	MEC 180M	400V Ø	39													1160	320	1260	256	6	
-	30	MEC 200L	400V Ø	53,5						100	300	1400	940	610	550	28	1240	320	1340	307	7		
KDN 50-125	0.37	-	MEC 71	230/400V	1,7-0,975	65	50	100	60	160	65	197	800	540	360	320	19	714	87	814	92	2	
	0.55	-	MEC 80	230/400V	2,6-1,5													757	90	857	95	2	
	0.75	-	MEC 80	230/400V	3,3-1,9														91		96	2	
	1.1	-	MEC 90S	230/400V	4,35-2,5													809	93	909	98	2	
	1.5	-	MEC 90L	230/400V	6-3,45								900	600	390	350			101		106	3	
	-	3	MEC 100L	400V Ø	5,9													846	105	946	135	3	
	-	4	MEC 112M	400V Ø	7,8													869	109	969	143	3	
	-	5.5	MEC 132S	400V Ø	10,2						80	212	1000	660	450	400	24	979	143	1079	146	4	
	-	7.5	MEC 132S	400V Ø	13,6														143		149	4	
	-	11	MEC 160M	400V Ø	19,6								240	1120	740	490		1089	143	1189	173	5	
KDN 50-160	0.55	-	MEC 80	230/400V	2,6-1,5	65	50	100	60	180	65	225	900	600	390	350	19	757	97	857	102	3	
	0.75	-	MEC 80	230/400V	3,3-1,9														98		103	3	
	1.1	-	MEC 90S	230/400V	4,35-2,5													809	100	909	105	3	
	1.5	-	MEC 90L	230/400V	6-3,45														103		108	3	
	2.2	-	MEC 100L	230/400V	7,95-4,6													846	107	946	112	3	
	3	-	MEC 100L	400V Ø	6,7														110		115	3	
	-	4	MEC 112M	400V Ø	7,8													869	132	969	137	3	
	-	5.5	MEC 132S	400V Ø	10,2						80	240	1000	660	450	400	24	979	143	1079	150	4	
	-	7.5	MEC 132S	400V Ø	13,6														177		151	4	
	-	11	MEC 160M	400V Ø	19,6								1120	740	490	440		1089	188	1189	175	5	
	-	15	MEC 160M	400V Ø	26,5														200		185	5	
-	18.5	MEC 160L	400V Ø	33													1134	202	1234	207	5		
KDN 50-200	0.75	-	MEC 80	230/400V	3,3-1,9	65	50	100	60	200	65	225	900	600	390	350	19	757	104	857	109	3	
	1.1	-	MEC 90S	230/400V	4,35-2,5													809	107	909	112	3	
	1.5	-	MEC 90L	230/400V	6-3,45														114		114	3	
	2.2	-	MEC 100L	230/400V	7,95-4,6													846	123	946	118	3	
	3	-	MEC 100L	400V Ø	6,7														122		121	3	
	4	-	MEC 112M	400V Ø	8,1													869	122	969	125	3	
	-	7.5	MEC 132S	400V Ø	13,6						80	240	1000	660	450	400	24	979	176	1079	169	4	
	-	11	MEC 160M	400V Ø	19,6								1120	740	490	440		1089	186	1189	181	5	
	-	15	MEC 160M	400V Ø	26,5														280		191	5	
	-	18.5	MEC 160L	400V Ø	33													1134	283	1234	213	5	
	-	22	MEC 180M	400V Ø	39								260					1164	290	1264	233	5	
	-	30	MEC 200L	400V Ø	53,5								280	1250	840	540	490	1244	290	1344	288	6	
	KDN 50-250	2.2	-	MEC 100L	230/400V	7,95-4,6	65	50	100	75	225	80	260	1000	660	450	400	24	846	135	946	139	4
3		-	MEC 100L	400V Ø	6,7														138		145	4	
4		-	MEC 112M	400V Ø	8,1													869	165	969	170	4	
5,5		-	MEC 132S	400V Ø	10,6								1120	740	490	440		979	173	1079	178	5	
-		15	MEC 160M	400V Ø	26,5								1250	840	540	490		1089	260	1189	265	6	
-		18.5	MEC 160L	400V Ø	33													1134	289	1234	275	6	
-		22	MEC 180M	400V Ø	39													1164	319	1264	304	6	
-		30	MEC 200L	400V Ø	53,5						100	300	1400	940	610	550	28	1244	407	1344	311	7	
-		37	MEC 200L	400V Ø	64,5														333		331	7	
-		45	MEC 225M	400V Ø	78													1299	374	1399	379	7	

Dimensions and electrical data of a complete motor-driven pump

MODEL	Power (kW)		MOTOR SIZE	Supply voltage 50 Hz	I nom (A)	Flange dimens. (mm)		Unit dimensions (mm)										Standard coupling		Spacer coupling		REF.
	4 poles	2 poles				DNA	DNM	A	A2	H2	H	H3	L1	L3	B2	B3	D	L	Weight Kg	L	Weight Kg	
KDN 65-125	0.37	–	MEC 71	230/400V	1,7-0,975	80	65	100	60	180	65	225	900	600	390	350	19	714	94	814	99	3
	0.55	–	MEC 80	230/400V	2,6-1,5													757	97	857	102	3
	0.75	–	MEC 80	230/400V	3,3-1,9														98		103	3
	1.1	–	MEC 90S	230/400V	4,35-2,5													809	100	909	105	3
	1.5	–	MEC 90L	230/400V	6-3,45														103		108	3
	2.2	–	MEC 100L	230/400V	7,95-4,6													846	107	946	112	3
	–	4	MEC 112M	400V Δ	7,8													869	132	969	137	3
	–	5.5	MEC 132S	400V Δ	10,2						80	240	1000	660	450	400	24	979	143	1079	148	4
	–	7.5	MEC 132S	400V Δ	13,6														146		151	4
	–	11	MEC 160M	400V Δ	19,6								1120	740	490	440		1089	175	1189	175	5
–	15	MEC 160M	400V Δ	26,5														180		185	5	
KDN 65-160	0.75	–	MEC 80	230/400V	3,3-1,9	80	65	100	60	200	65	225	900	600	390	350	19	757	101	857	106	3
	1.1	–	MEC 90S	230/400V	4,35-2,5													809	103	909	108	3
	1.5	–	MEC 90L	230/400V	6-3,45														114		111	3
	2.2	–	MEC 100L	230/400V	7,95-4,6													846	114	946	115	3
	3	–	MEC 100L	400V Δ	6,7														148		118	3
	–	5.5	MEC 132S	400V Δ	10,2						80	240	1000	660	450	400	24	979	149	1079	153	4
	–	7.5	MEC 132S	400V Δ	13,6														173		154	4
	–	11	MEC 160M	400V Δ	19,6								1120	740	490	440		1089	183	1189	178	5
	–	15	MEC 160M	400V Δ	26,5														220		188	5
	–	18.5	MEC 160L	400V Δ	33													1134	220	1234	210	5
–	22	MEC 180M	400V Δ	39								260					1164	220	1264	230	5	
KDN 65-200	1.1	–	MEC 90S	230/400V	4,35-2,5	80	65	100	75	225	80	260	1000	660	450	400	24	809	141	909	146	4
	1.5	–	MEC 90L	230/400V	6-3,45														143		148	4
	2.2	–	MEC 100L	230/400V	7,95-4,6								1120	740	490	440		846	147	946	152	5
	3	–	MEC 100L	400V Δ	6,7														150		155	5
	4	–	MEC 112M	400V Δ	8,1													869	150	969	159	5
	5,5	–	MEC 132S	400V Δ	10,6													979	200	1079	176	5
	–	11	MEC 160M	400V Δ	19,6								1250	840	540	490		1089	267	1189	241	6
	–	15	MEC 160M	400V Δ	26,5														279		252	6
	–	18.5	MEC 160L	400V Δ	33													1134	289	1234	262	6
	–	22	MEC 180M	400V Δ	39													1164	332	1264	266	6
–	30	MEC 200L	400V Δ	53,5						100	300	1400	940	610	550	28	1244	406	1344	317	7	
–	37	MEC 200L	400V Δ	64,5														406		337	7	
KDN 65-250	3	–	MEC 100L	400V Δ	6,7	80	65	100	90	250	80	280	1120	740	490	440	24	956	178	1096	183	5
	4	–	MEC 112M	400V Δ	8,1													979	185	1119	186	5
	5,5	–	MEC 132S	400V Δ	10,6													1089	201	1229	203	5
	7.5	–	MEC 132M	400V Δ	14,4														257		211	5
	11	–	MEC 160M	400V Δ	20,8								1250	840	540	490		1199	257	1339	253	6
	–	22	MEC 180M	400V Δ	39													1274	319	1414	337	6
	–	30	MEC 200L	400V Δ	53,5						100	300	1400	940	610	550	28	1354	460	1494	422	7
	–	37	MEC 200L	400V Δ	64,5														477		442	7
	–	45	MEC 225M	400V Δ	78							325						1409	550	1549	517	7
	–	55	MEC 250M	400V Δ	94,5								350	1600	1060	660	600	28	1519	672	1659	612
KDN 65-315	5,5	–	MEC 132S	400V Δ	10,6	80	65	125	90	280	80	305	1250	840	540	490	24	1114	259	1254	244	6
	7.5	–	MEC 132M	400V Δ	14,4														292		249	6
	11	–	MEC 160M	400V Δ	20,8													1224	297	1364	268	6
	15	–	MEC 160L	400V Δ	27						100	325	1400	940	610	550	28	1269	297	1409	306	7
	18.5	–	MEC 180M	400V Δ	33													1299	322	1439	327	7
	–	45	MEC 225M	400V Δ	78								1600	1060	660	600	28	1434	695	1574	582	8
	–	55	MEC 250M	400V Δ	94,5													1544	695	1684	677	8
	–	75	MEC 280S	400V Δ	128								1800	1200	730	670	28	1569	849	1709	827	9
	–	90	MEC 280M	400V Δ	160													1619	669	1759	887	9
	–	110	MEC 315S	400V Δ	188								2000	1340	910	830	28	1944	1119	2084	1007	9

Dimensions and electrical data of a complete motor-driven pump

MODEL	Power (kW)		MOTOR SIZE	Supply voltage 50 Hz	I nom (A)	Flange dims. (mm)		Unit dimensions (mm)													Standard coupling		Spacer coupling		REF.
	4 poles	2 poles				DNA	DNM	A	A2	H2	H	H3	L1	L3	B2	B3	D	L	Weight Kg	L	Weight Kg				
KDN 80-160	1.1	-	MEC 90S	230/400V	4,35-2,5	100	80	125	75	225	80	260	1000	660	450	400	24	834	125	974	130	4			
	1.5	-	MEC 90L	230/400V	6-3,45														127		132	4			
	2.2	-	MEC 100L	230/400V	7,95-4,6														871	139	1011	136	4		
	3	-	MEC 100L	400V Δ	6,7															138		139	4		
	4	-	MEC 112M	400V Δ	8,1															894	138	1134	143	4	
	5,5	-	MEC 132S	400V Δ	10,6								1120	740	490	440			1004	163	1144	168	5		
	-	7.5	MEC 132S	400V Δ	13,6															189		194	5		
	-	11	MEC 160M	400V Δ	19,6								1250	840	540	490			1114	298	1254	236	6		
	-	15	MEC 160M	400V Δ	26,5															298		237	6		
	-	18.5	MEC 160L	400V Δ	33															1159	298	1299	238	6	
	-	22	MEC 180M	400V Δ	39															1189	253	1329	258	6	
	-	30	MEC 200L	400V Δ	53,5						100	300	1400	940	610	550	28	1269	304	1409	309	7			
-	37	MEC 200L	400V Δ	64,5														383		388	7				
KDN 80-200	1.5	-	MEC 90L	230/400V	6-3,45	100	80	125	75	250	80	260	1120	740	490	440	24	944	161	1084	166	5			
	2.2	-	MEC 100L	230/400V	7,95-4,6														981	166	1121	171	5		
	3	-	MEC 100L	400V Δ	6,7															168		173	5		
	4	-	MEC 112M	400V Δ	8,1														1004	188	1144	177	5		
	5,5	-	MEC 132S	400V Δ	10,6															1114	188	1254	194	5	
	7.5	-	MEC 132M	400V Δ	14,4															188		202	5		
	11	-	MEC 160M	400V Δ	20,8								1250	840	540	490			1224	197	1364	244	6		
	-	18.5	MEC 160L	400V Δ	33															1269	239	1409	299	6	
	-	22	MEC 180M	400V Δ	39															1299	275	1439	328	6	
	-	30	MEC 200L	400V Δ	53,5						100	300	1400	940	610	550	28	1379	432	1519	335	7			
	-	37	MEC 200L	400V Δ	64,5														455		355	7			
	-	45	MEC 225M	400V Δ	78							325							1434	548	1574	403	7		
	-	55	MEC 250M	400V Δ	94,5							350	1600	1060	660	600			1544	494	1684	499	8		
	-	75	MEC 280S	400V Δ	128							380	1800	1200	730	670			1569	609	1709	614	9		
KDN 80-250	4	-	MEC 112M	400V Δ	8,1	100	80	125	90	280	80	280	1250	840	540	490	24	1004	219	1144	223	6			
	5.5	-	MEC 132S	400V Δ	10,6														1114	219	1254	239	6		
	7.5	-	MEC 132M	400V Δ	14,4															219		244	6		
	11	-	MEC 160M	400V Δ	20,8															1224	258	1364	263	6	
	15	-	MEC 160L	400V Δ	27															1269	277	1409	282	6	
	-	37	MEC 200L	400V Δ	64,5						100	300	1400	940	610	550	28	1379	471	1519	478	7			
	-	45	MEC 225M	400V Δ	78															1434	545	1574	553	7	
	-	55	MEC 250M	400V Δ	94,5								1600	1060	660	600			1544	650	1684	648	8		
	-	75	MEC 280S	400V Δ	128								1800	1200	730	670			1569	641	1709	798	9		
	-	90	MEC 280M	400V Δ	160														1619	909	1759	858	9		
KDN 80-315	7.5	-	MEC 132M	400V Δ	14,4	100	80	125	90	315	80	330	1250	840	540	490	24	1114	390	1254	284	6			
	11	-	MEC 160M	400V Δ	20,8														1224	390	1364	315	6		
	15	-	MEC 160L	400V Δ	27						100	350	1400	940	610	550	28	1269	390	1409	318	7			
	18.5	-	MEC 180M	400V Δ	33														1299	409	1439	344	7		
	22	-	MEC 180L	400V Δ	39														1339	348	1479	353	7		
	30	-	MEC 200L	400V Δ	52,5														1379	384	1519	389	7		
	-	55	MEC 250M	400V Δ	94,5								1600	1060	660	600			1544	707	1684	689	8		
	-	75	MEC 280S	400V Δ	128								1800	1200	730	670			1569	861	1709	839	9		
	-	90	MEC 280M	400V Δ	160														1619	681	1759	899	9		
	-	110	MEC 315S	400V Δ	188						120	370	2000	1340	910	830			1944	1131	2084	1019	9		

Dimensions and electrical data of a complete motor-driven pump

MODEL	Power (kW)		MOTOR SIZE	Supply voltage 50 Hz	I nom (A)	Flange dims. (mm)		Unit dimensions (mm)										Standard coupling		Spacer coupling		REF.	
	4 poles	2 poles				DNA	DNM	A	A2	H2	H	H3	L1	L3	B2	B3	D	L	Weight Kg	L	Weight Kg		
KDN 100-200	3	-	MEC 100L	400V Ø	6,7	125	100	125	90	280	80	280	1120	740	490	440	24	981	181	1121	186	5	
	4	-	MEC 112M	400V Ø	8,1													1004	188	1144	193	5	
	5,5	-	MEC 132S	400V Ø	10,6													1114	214	1254	206	5	
	7,5	-	MEC 132M	400V Ø	14,4														209			214	5
	11	-	MEC 160M	400V Ø	20,8								1250	840	540	490		1224	307	1364	256	6	
	15	-	MEC 160L	400V Ø	27													1269	380	1409	275	6	
	-	30	MEC 200L	400V Ø	53,5						100	300	1400	940	610	550	28	1379	454	1519	425	7	
	-	37	MEC 200L	400V Ø	64,5														402			445	7
	-	45	MEC 225M	400V Ø	78							325						1434	549	1574	520	7	
	-	55	MEC 250M	400V Ø	94,5							350	1600	1060	660	600		1544	623	1684	615	8	
	-	75	MEC 280S	400V Ø	128							380	1800	1200	730	670		1569	621	1709	765	9	
	-	90	MEC 280M	400V Ø	160													1619	621	1759	825	9	
KDN 100-250	5.5	-	MEC 132S	400V Ø	10,6	125	100	140	90	280	80	305	1250	840	540	490	24	1129	241	1269	246	6	
	7.5	-	MEC 132M	400V Ø	14,4														250			255	6
	11	-	MEC 160M	400V Ø	20,8													1239	292	1379	270	6	
	15	-	MEC 160L	400V Ø	27						100	325	1400	940	610	550	28	1284	300	1424	308	7	
	18.5	-	MEC 180M	400V Ø	33													1314	578	1454	329	7	
	-	45	MEC 225M	400V Ø	78								1600	1060	660	600		1449	696	1589	583	8	
	-	55	MEC 250M	400V Ø	94,5													1559	696	1699	678	8	
	-	75	MEC 280S	400V Ø	128								380	1800	1200	730	670		1584	850	1724	828	9
	-	90	MEC 280M	400V Ø	160													1634	670	1774	888	9	
	-	110	MEC 315S	400V Ø	188						120	435	2000	1340	910	830		1959	1120	2099	1008	9	
KDN 100-315	11	-	MEC 160M	400V Ø	20,8	125	100	140	90	315	80	330	1250	840	540	490	24	1239	313	1379	319	6	
	15	-	MEC 160L	400V Ø	27						100	350	1400	940	610	550	28	1284	300	1424	335	7	
	18.5	-	MEC 180M	400V Ø	33													1314	346	1454	363	7	
	22	-	MEC 180L	400V Ø	39													1354	372	1494	373	7	
	30	-	MEC 200L	400V Ø	52,5													1394	458	1534	463	7	
	37	-	MEC 225S	400V Ø	64													1479	518	1619	523	7	
KDN 125-250	7.5	-	MEC 132M	400V Ø	14,4	150	125	140	90	355	80	330	1250	840	540	490	24	1129	310	1269	294	6	
	11	-	MEC 160M	400V Ø	20,8													1239	328	1379	325	6	
	15	-	MEC 160L	400V Ø	27						100	350	1400	940	610	550	28	1284	416	1424	328	7	
	18.5	-	MEC 180M	400V Ø	33													1314	422	1454	349	7	
	22	-	MEC 180L	400V Ø	39													1354	463	1494	358	7	
	30	-	MEC 200L	400V Ø	52,5													1394	511	1534	394	7	
KDN 150-200	5.5	-	MEC 132S	400V Ø	10,6	200	150	160	110	400	100	380	1800	1200	730	670	28	1099	454	1239	377	9	
	7.5	-	MEC 132M	400V Ø	14,4														454			386	9
	11	-	MEC 160M	400V Ø	20,8													1209	454	1349	401	9	
	15	-	MEC 160L	400V Ø	27													1254	454	1394	420	9	
	18.5	-	MEC 180M	400V Ø	33													1284	454	1424	441	9	

PERFORMANCE RANGE

GRAPHICAL SELECTION TABLE

The performance curves are based on the kinematic viscosity values = 1 mm²/s and density equal to 1000 kg/m³. Curve tolerance according to ISO 9906.

= 2900 1/min

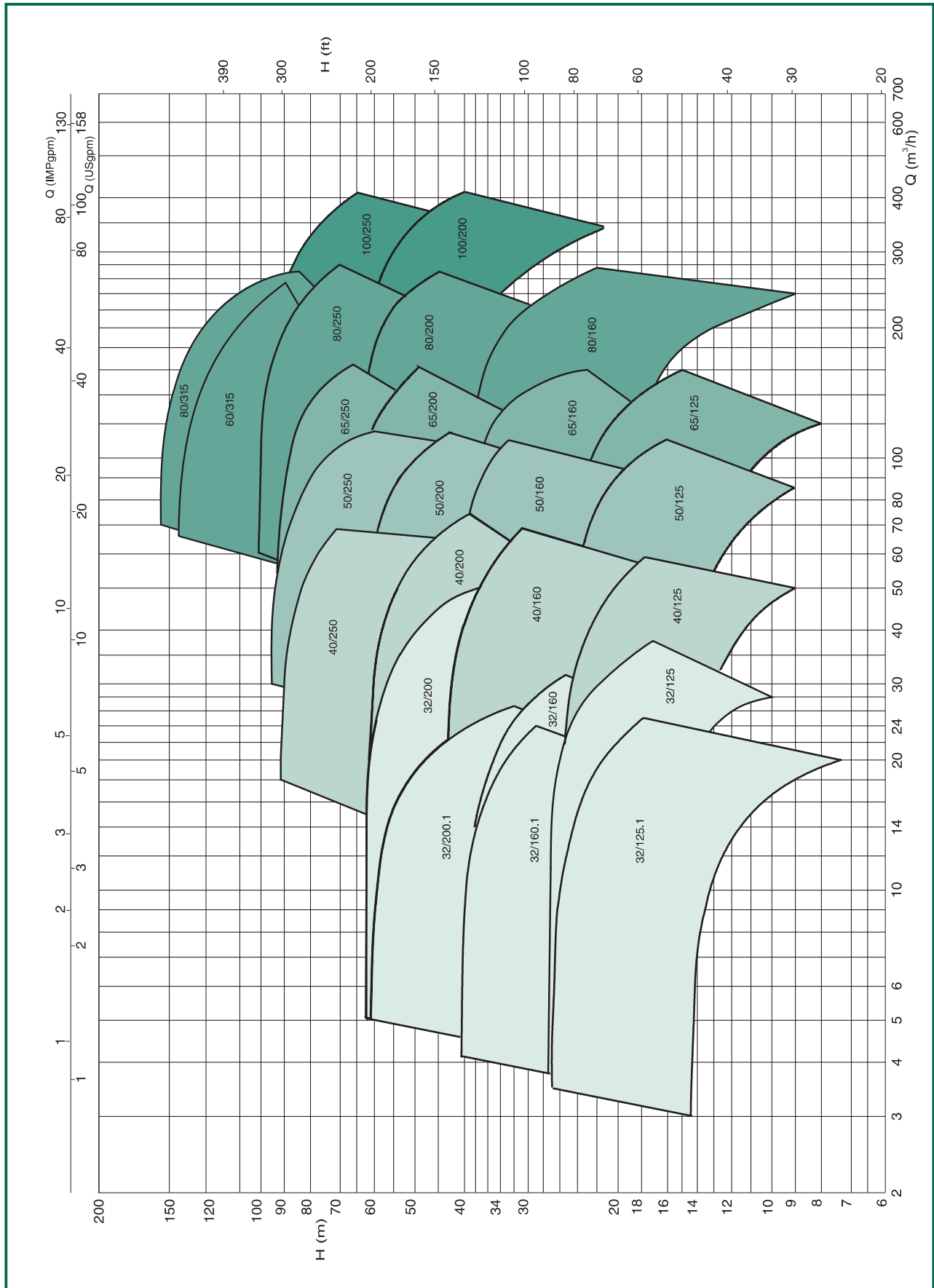

PERFORMANCE RANGE

KDN 2 POLES

NUMERICAL SELECTION TABLE

= 2900 1/min

MODEL	Q		H (m)													
	m ³ /h	l/min	0	6	12	18	24	30	36	42	48	54	60	66	72	
			0	100	200	300	400	500	600	700	800	900	1000	1100	1200	
KDN 32-125.1/105			13.8	13.6	12.3	9.7										
KDN 32-125.1/110			15.5	15.2	13.9	11.5										
KDN 32-125.1/115			17.1	16.8	15.5	13.2										
KDN 32-125.1/120			18.8	18.5	17.3	15.1										
KDN 32-125.1/125			20.5	20.3	19.1	17										
KDN 32-125.1/130			22.3	22.2	21.3	19										
KDN 32-125.1/135			24.4	24.1	23.3	21.1	17.8									
KDN 32-125.1/140			26.5	26.4	25.6	23.4	20.1									
KDN 32-125/115			17.3		16.5	15.1	12.9									
KDN 32-125/120			19		18.2	17	14.9	11.1								
KDN 32-125/125			20.9		20.1	18.9	16.9	13.5								
KDN 32-125/130			22.9		22	21	19.1	16.2								
KDN 32-125/135			24.9		24	22.1	21.5	18.5	14.7							
KDN 32-125/142			27.8		27	26.1	24.5	21.7	18							
KDN 32-160.1/137			21.5	21.2	19.3											
KDN 32-160.1/145			24.7	24.5	22.3	16.5										
KDN 32-160.1/153			28.3	28	26	20.5										
KDN 32-160.1/161			32	31.8	30	25										
KDN 32-160.1/169			36	35.7	34.4	29.5										
KDN 32-160.1/177			39.5	39.3	38.2	34.5	26									
KDN 32-160/137			23.7		22.6	20.7	17.6									
KDN 32-160/145			27		25.8	23.9	21.2	16.9								
KDN 32-160/153			30.4		29.5	27.7	25.8	21.2								
KDN 32-160/161			34		33	31.7	29.1	25.5								
KDN 32-160/169			38		37.3	36	33.6	35.7	26.5							
KDN 32-160/177			41.8		41.5	40.5	38.4	35.3	31.4							
KDN 32-200.1/170			34.3	34.2	31.9	23.5										
KDN 32-200.1/180			39.4	39.2	36.7	30										
KDN 32-200.1/190			45.3	44.7	41.5	35.5										
KDN 32-200.1/200			51.5	51	47.3	41	35									
KDN 32-200.1/207			55.3	55	51.8	46.4	37									
KDN 32-200/170			34		33	31	27	21								
KDN 32-200/180			39		38.5	36.5	32.5	28								
KDN 32-200/190			45		43.5	42	39	34	28.5							
KDN 32-200/200			51		49	48	45	40.5	35							
KDN 32-200/210			57		56	55	52.5	48.5	43	36						
KDN 32-200/219			63		62	61	59	56.5	52.5	46.5	39.5					

PERFORMANCE RANGE

KDN 2 POLES

NUMERICAL SELECTION TABLE

= 2900 1/min

MODEL	Q													
	m ³ /h	0	6	12	18	24	30	36	42	48	54	60	66	72
	l/min	0	100	200	300	400	500	600	700	800	900	1000	1100	1200
KDN 40-125/115		16.8		13.3	15.6	15	14.3	13.2	12.6	9.8				
KDN 40-125/120		18.5		18	17.5	17	16	15	13.5	11.8				
KDN 40-125/125		20.4		20	19.5	19	18	16.7	15.3	13.5				
KDN 40-125/130		22		21.8	21.5	21	20	19	17.5	15.7	14			
KDN 40-125/135		24.1		24	23.9	23.4	22.5	21.5	20	18.3	16.4			
KDN 40-125/142		26.8		26.6	26.4	26	25.3	24.4	23	21.4	19.4	17		
KDN 40-160/137		23.9			23.8	23	22	20.5	18	15				
KDN 40-160/145		27.5			27.4	27	25.7	24.2	22.1	19.5				
KDN 40-160/153		31.1			31	30.5	29.5	28	26.5	24	21			
KDN 40-160/161		34.5			34.5	34.4	33.7	32.3	30.5	28.5	25.8	22.5		
KDN 40-160/169		38.4			38.4	38.2	38	37	35	33.5	31	28		
KDN 40-160/177		42.6			42.5	42.4	42	41.5	40	38.5	35	33	30	
KDN 40-200/170		33.6			33	32.6	32	30	26.5	22.5				
KDN 40-200/180		38.8			38.5	38	37	35	32.5	29	25			
KDN 40-200/190		43.4			43.1	43	42.7	41	38	35	31.5	27		
KDN 40-200/200		48.7			48.4	48.2	47.5	46.5	44	41.5	38.5	34.5		
KDN 40-200/210		54.3			54.1	54	53.6	53	51	48.5	46	42.5	38	
KDN 40-200/219		60			59.8	59.7	59.4	59	57	55	52.5	49.5	46	40
KDN 40-250/220		63.1			62.8	62.5	61	59	57	55	52	48		
KDN 40-250/230		69.5			69.3	68.5	67.8	66	63.5	61	58	55	51	
KDN 40-250/240		76.3			76	75.8	75	73	70.5	68	65	62	58.5	
KDN 40-250/250		82.8			82.5	82	81.8	80	78	75.5	72.5	69	66	
KDN 40-250/260		91			90.5	90	89.5	88.5	86.5	84	81	78	74	
KDN 50-125/115	H (m)	17.1					15.9	15.5	15	14.3	13.6	13	12.2	11.5
KDN 50-125/120		18.2					17.5	17	16.5	16	15.3	14.7	14	13.2
KDN 50-125/125		19.8					19.4	19	18.5	17.9	17.4	16.6	16	15.1
KDN 50-125/130		21.5					21.1	20.8	20.5	19.8	19.2	18.5	17.8	17
KDN 50-125/135		23.2					23	22.6	22.3	21.8	21.2	20.6	19.9	19.3
KDN 50-125/139		24.7					24.5	24.3	24	23.5	23	22.4	21.6	20.8
KDN 50-125/144		25.9					26.5	26.4	26.1	25.6	25.1	24.5	24	23.2
KDN 50-160/137		24.2					23.8	23.7	23.5	22.5	22	21	20.3	19
KDN 50-160/145		27.2					27	26.9	26.6	26.4	25.5	25	23.8	23
KDN 50-160/153		30.3					30.3	30.2	30	29.9	29.5	28.5	27.7	26.5
KDN 50-160/161		33.8					33.7	33.7	33.6	33.6	33.3	32.5	31.8	31
KDN 50-160/169		37.7					37.7	37.5	37.5	37.4	37	36.2	35.7	35.5
KDN 50-160/177		41.6					41.5	41.5	41.3	41.2	41	40.6	40.5	39.5
KDN 50-200/170		37.9					37	36.8	36.4	35	34	32	30	27
KDN 50-200/180		42.5					42	41.7	41.4	40.5	39.5	38	36	34
KDN 50-200/190		47.2					46.8	46.6	46	45.7	44.5	43.5	42	40
KDN 50-200/200		52.4					52.2	52	51.8	51.5	50.5	49	47.5	46
KDN 50-200/210		58.4					58.4	58.2	58	57.5	56.5	55.5	54	52.5
KDN 50-200/219		64					64	64	64	63.5	62.5	61.5	60	58.5
KDN 50-250/220		63.7					63.3	63.1	63	62	61	59	57.5	55
KDN 50-250/230		69.6					69.3	69	68.8	68.5	68	66	64	62
KDN 50-250/240		76					75.8	75.5	75.3	75	74.5	73	71.5	69
KDN 50-250/250		83.2					83	82.9	82.8	83.5	82	80.5	78.5	77
KDN 50-250/263		92.1					92	91.8	91.6	91.5	91.3	89.9	88.5	86.5

PERFORMANCE RANGE

KDN 2 POLES

NUMERICAL SELECTION TABLE

= 2900 1/min

MODEL	Q													
	m ³ /h	0	6	12	18	24	30	36	42	48	54	60	66	72
	l/min	0	100	200	300	400	500	600	700	800	900	1000	1100	1200
KDN 65-125/120/110		16								14.4	14	13.6	13.1	12.8
KDN 65-125/120		17.8								16	15.6	15.3	14.9	14.4
KDN 65-125/125		19.4								17.8	17.5	17.1	16.8	16.4
KDN 65-125/130		21								19.6	19.5	19.1	18.9	18.5
KDN 65-125/135		22.6								21.8	21.5	21.3	21	20.5
KDN 65-125/140		24								23.6	23.5	23.4	23	22.8
KDN 65-125/144		25.6								25.5	25.4	25.2	25	24.6
KDN 65-160/137		23.1								22.4	22	21.7	21.3	20.5
KDN 65-160/145		26.2								25.7	25.5	25	24.6	24
KDN 65-160/153		29.1								28.8	28.5	28.6	28.5	28
KDN 65-160/161		32.6								32.5	32.4	32.3	32	31.7
KDN 65-160/169		36.4								36.3	36.2	36.1	36	35.7
KDN 65-160/177		40.1								39.9	39.8	39.7	40	39.8
KDN 65-200/170		37.2								36.8	36.7	36.6	36.5	36
KDN 65-200/180		41.7								41.4	41.3	41.2	41.1	41
KDN 65-200/190		48.3								48.2	48.1	48	47.9	47.5
KDN 65-200/200		53.2								53.1	52.9	52.8	52.7	52.5
KDN 65-200/210		59.2								59.1	59	58.9	58.8	58.7
KDN 65-200/219		64.9								64.9	64.8	64.5	64.3	64.1
KDN 65-250/220		63.2								62.8	62.5	62	61	60
KDN 65-250/230		69.5								69.5	69	68.5	68	67
KDN 65-250/240		76								75.7	75.5	75	75	74
KDN 65-250/250		83								82.3	82.3	82.2	82	81.5
KDN 65-250/263		92.6								91.8	91.8	91.7	91.5	91.5
KDN 65-315/260		92.8											92.7	91.9
KDN 65-315/275		105											104.5	103.9
KDN 65-315/290		117.1											117.0	116.5
KDN 65-315/305		130											129.6	129.2
KDN 65-315/320		143											142.9	142.6
KDN 80-160/147/127		23												
KDN 80-160/153/136		25.6												
KDN 80-160/153		29.3												
KDN 80-160/161		32.8												
KDN 80-160/169		36.5												
KDN 80-160/177		40												
KDN 80-200/170		36.6												
KDN 80-200/180		41												
KDN 80-200/190		45.7												
KDN 80-200/200		50.8												
KDN 80-200/210		56.3												
KDN 80-200/222		63.6												
KDN 80-250/220		62.6												
KDN 80-250/230		68.3												
KDN 80-250/240		75.5												
KDN 80-250/250		82.5												
KDN 80-250/260		90												
KDN 80-250/270		97.9												
KDN 80-315/275		106												
KDN 80-315/290		118												
KDN 80-315/305		131												
KDN 80-315/320		143												
KDN 80-315/334		156												
KDN 100-200/180		40.4												
KDN 100-200/190		46.5												
KDN 100-200/200		51.5												
KDN 100-200/210		57.5												
KDN 100-200/219		64												
KDN 100-250/220		61.1												
KDN 100-250/230		67.4												
KDN 100-250/240		73.5												
KDN 100-250/250		79.7												
KDN 100-250/260		88.6												

78	84	90	102	114	120	150	180	210	240	270	300	330	360	390	420
1300	1400	1500	1700	1900	2000	2500	3000	3500	4000	4500	5000	5500	6000	6500	7000
12.2	11.9	11.4	10.2	8.7	8										
13.9	13.4	13	11.5	10.3	9.4										
16	15.4	15	13.5	12.2	11.4										
18	17.5	17	15.7	14.2	13.2										
20.1	19.6	19.2	18	16.5	15.6										
22.3	22	21.4	20.3	18.9	18	13.8									
24.3	24	23.4	22.5	21.1	20.2	16									
19.7	19	18	16												
23.5	22.7	22	20	17.8	16.5										
27.5	26.6	26	24	22	21										
31.3	30.5	30	28.5	26.5	25.5										
35.3	34.7	34	32.7	31	30										
39.5	39	38.5	37.2	35.5	34.7	28.5									
35	34	32.5	30	27	25										
40.5	40	39	36.5	34	32										
47	41	45	43	40.5	39										
52.3	52	51.8	50	48	46.5										
58.5	58.2	58	56.5	54.5	53.5										
64	63.8	62.5	62.4	61	60	52.5									
59.5	58	57	54	50.5	48										
66	65	64	63	58.5	56.5										
73	72	71	69	66	64										
81	80	79	76.5	73.5	72	60									
91	90	89.5	87.5	85	83	72.5									
90.9	89.7	88.5	85.5	81.9	79.9	67.8									
103.1	102.1	101.1	98.5	95.5	93.8	83.3	69.5								
115.9	115.1	114.3	112.2	109.7	108.3	99.4	87.6								
128.7	128.0	127.3	125.5	123.2	121.9	113.8	103.0	89.6							
142.1	141.6	140.9	139.3	137.3	136.2	128.9	119.1	106.8	92.0						
		21.5	20.7	20	19.5	17	14.5	11.8	8.8						
		24.5	23.8	23	22.5	20.2	17.5	15	11.8						
		28	27.3	26.5	26	23.5	20.7	16.5	14.5						
		32	31.5	30.5	30	27.8	25	21.5	18.5						
		35.7	35.2	34.5	34.2	32	29.5	26.5	22.6	18.5					
		39.5	39.2	38.7	38.5	37	34.8	31.8	27.8	23					
		35.7	35.5	34.5	34	31	27	21.5							
		40.6	40.5	40	39.5	37	33	27.5							
		45.4	45	44.5	44	42	29	34							
		50.4	50.2	50	49.6	49	46.5	41	35						
		55.9	55.8	55.7	55.6	54.8	52	48	43						
		63.4	63.3	63.2	63.1	63	60	56.5	51.5	45					
		62.5	62.4	62	61.8	60	55.5	49							
		68.2	68.1	68	67.9	67	63	57	50						
		75.4	75.3	75.2	75	74.5	71	65.5	58.5						
		82.3	82	81.9	81.7	82	78.5	74	67.5	60.5					
		89.7	89.6	86.5	89.3	89	86.5	82	77	70	61.5				
		97.8	97.5	91.3	97	96.5	94	89	84	77	69				
		106.1	105.3	104.3	103.7	99.4	93.4	85.6	76.0						
		118.4	117.8	117.1	116.6	113.2	108.2	101.5	93.2	83.4					
		130.9	130.7	130.3	130.1	128.1	125.1	121.0	115.9						
		143.2	143.0	142.6	142.4	140.7	138.0	134.5							
		155.5	155.4	155.3	155.2	154.3									
						40	38	36	33	30.5	28	25			
						45	44	42	39	37	34.5	31	28		
						51	50	48.5	46	44	42	39	35	31.5	
						57	56	55	53	51	49	46	43	39	36
						62.5	62	61	60	58	56	53	50	47	43
						60	59.5	57	54	50.5	46.5	42			
						66.9	66.5	64	61	58	54	49	44		
						72.9	71	70.5	69	66	63	58.5	53		
						79.5	79	78.8	77	74	71	67	62.5		
						88.2	88.1	88	86	83	79.5	76	71.5	66	

KDN 32-125.1

= 2900 1/min

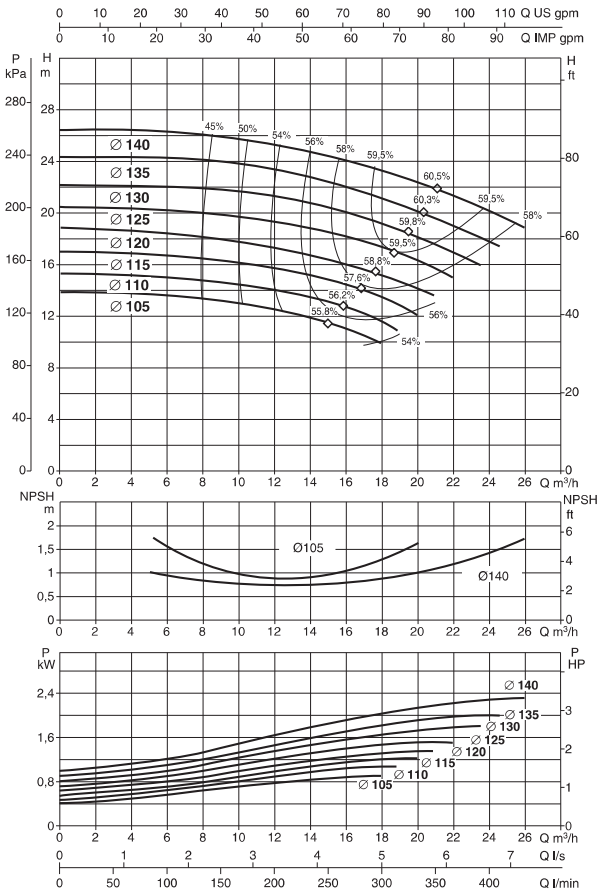

KDN 32-125

= 2900 1/min

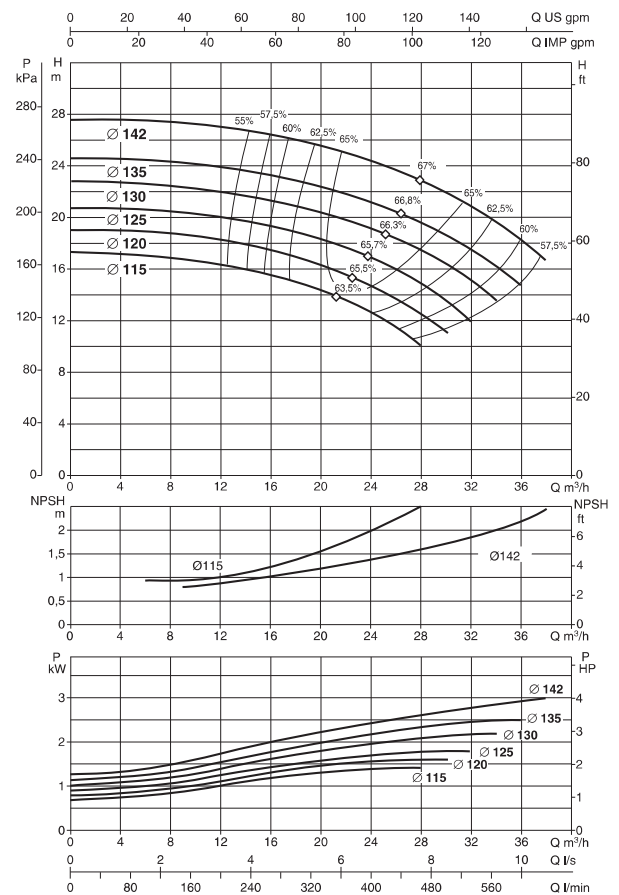

KDN 32-160.1

= 2900 1/min

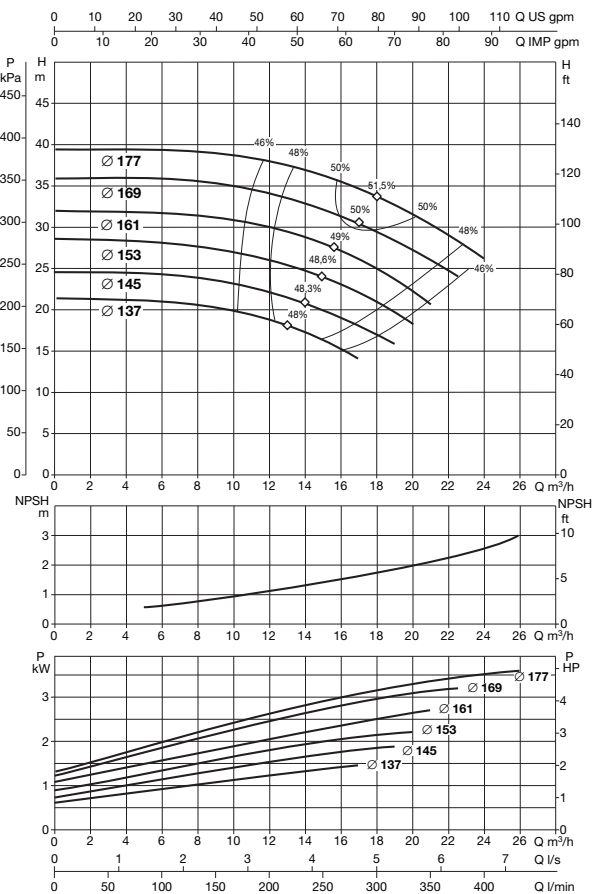

KDN 32-160

= 2900 1/min

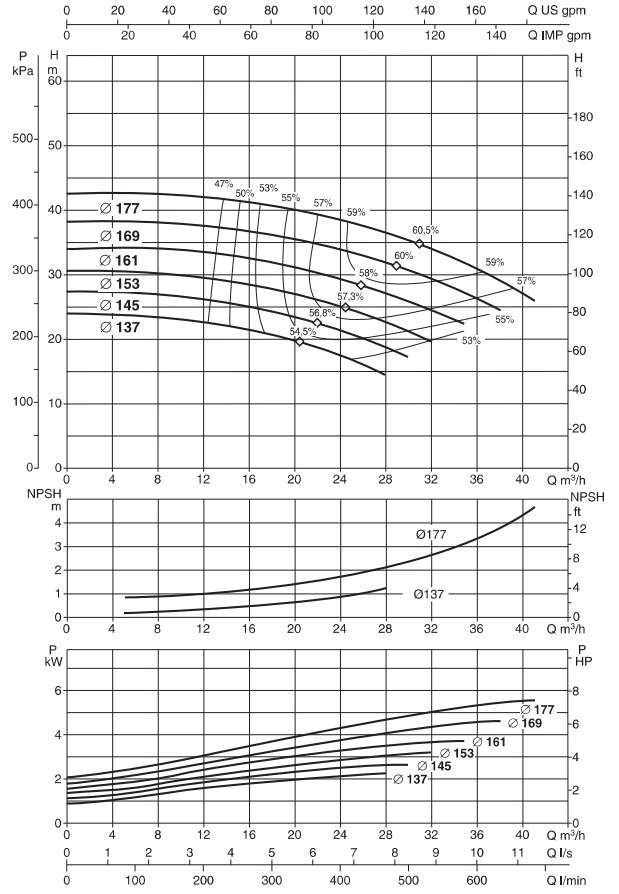

KDN 32-200.1

= 2900 1/min

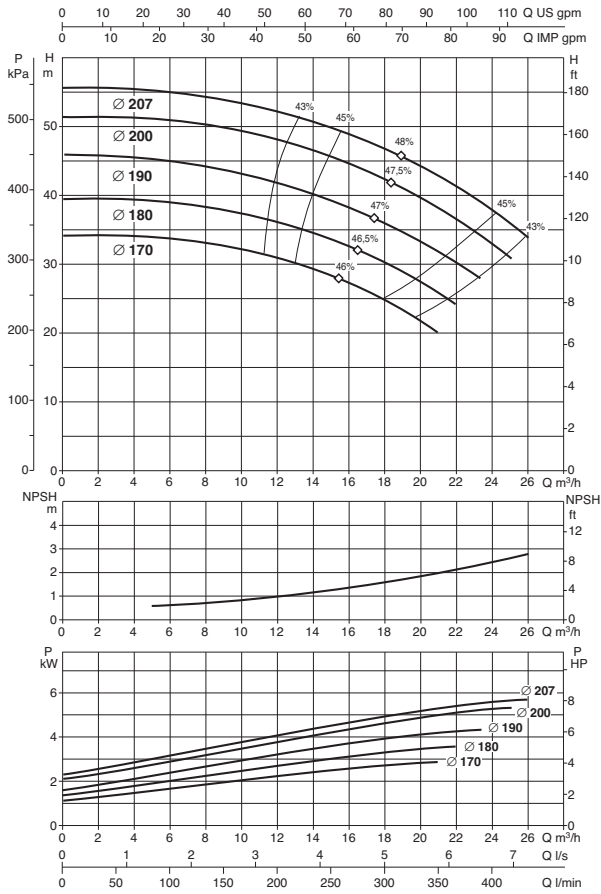

KDN 32-200

= 2900 1/min

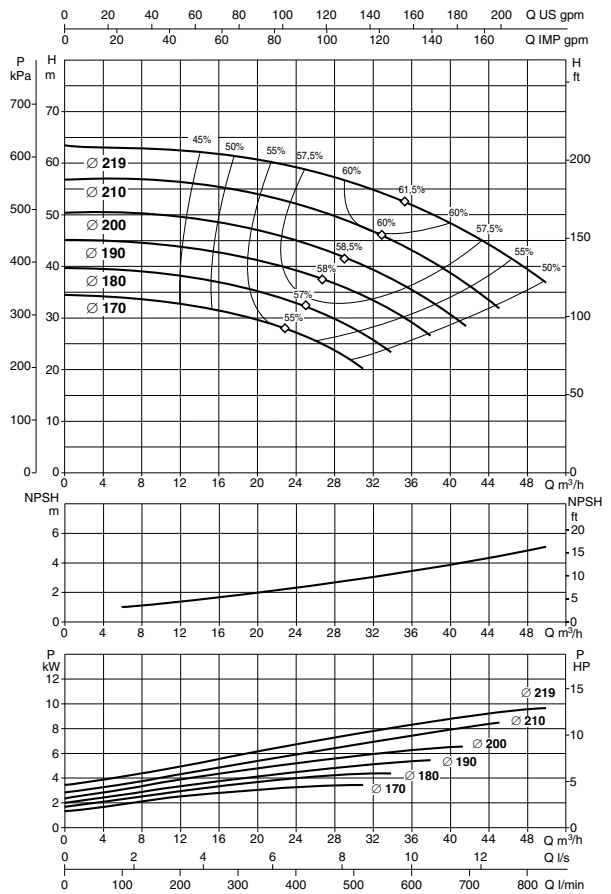

KDN 40-125

= 2900 1/min

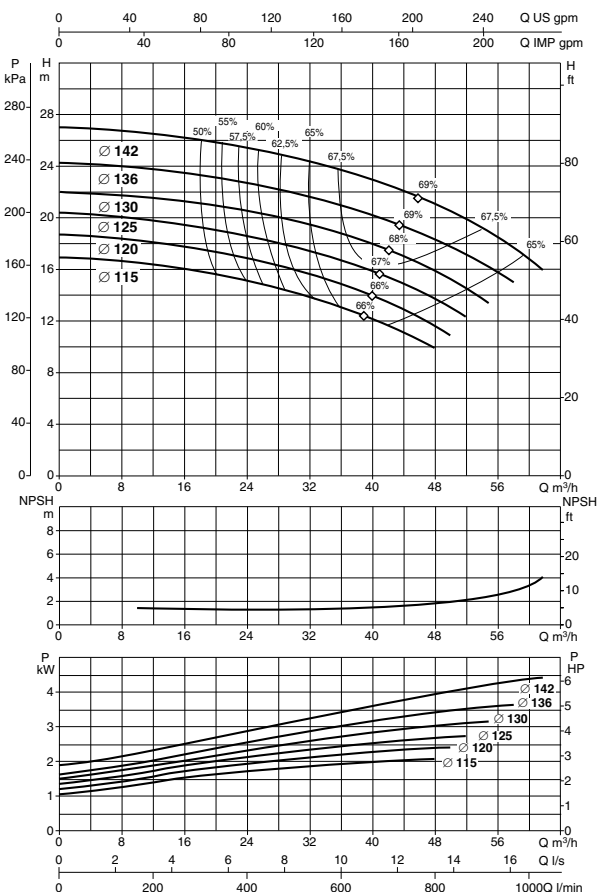

KDN 40-160

= 2900 1/min

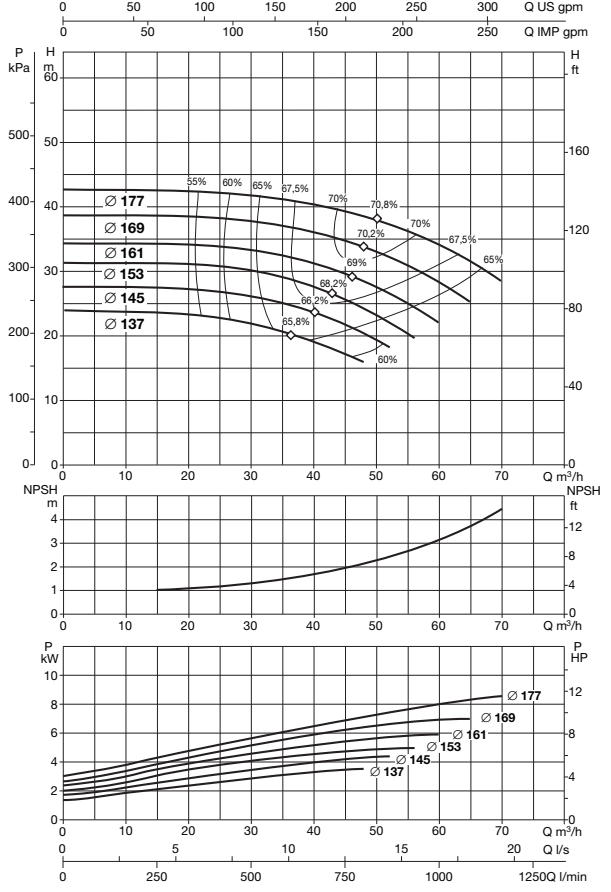

KDN 40-200 = 2900 1/min

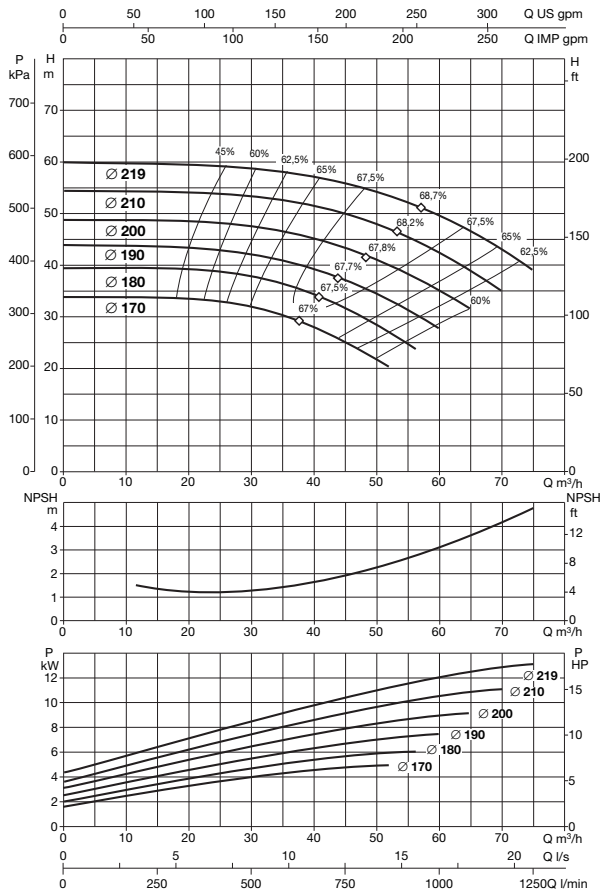

KDN 40-250 = 2900 1/min

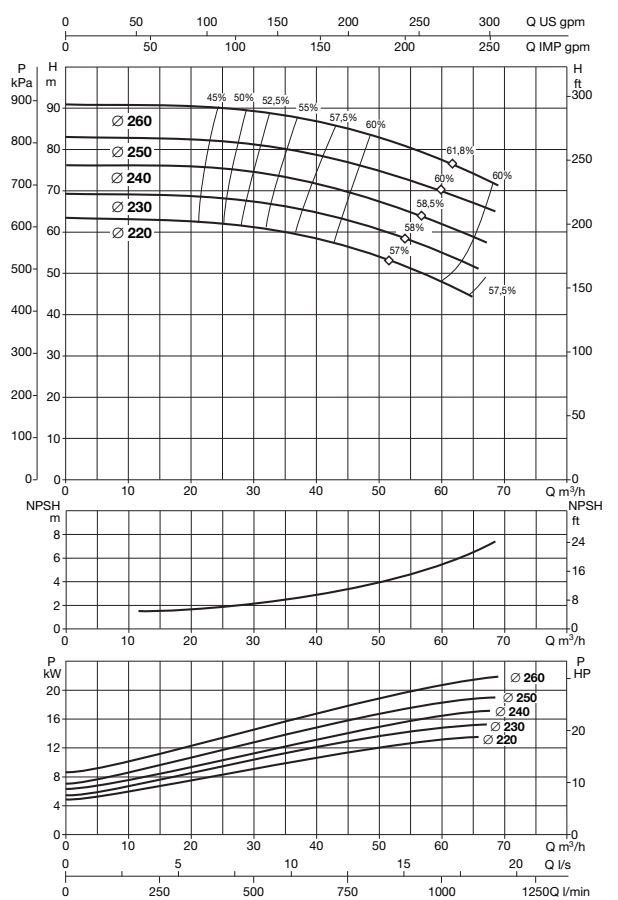

KDN 50-125 = 2900 1/min

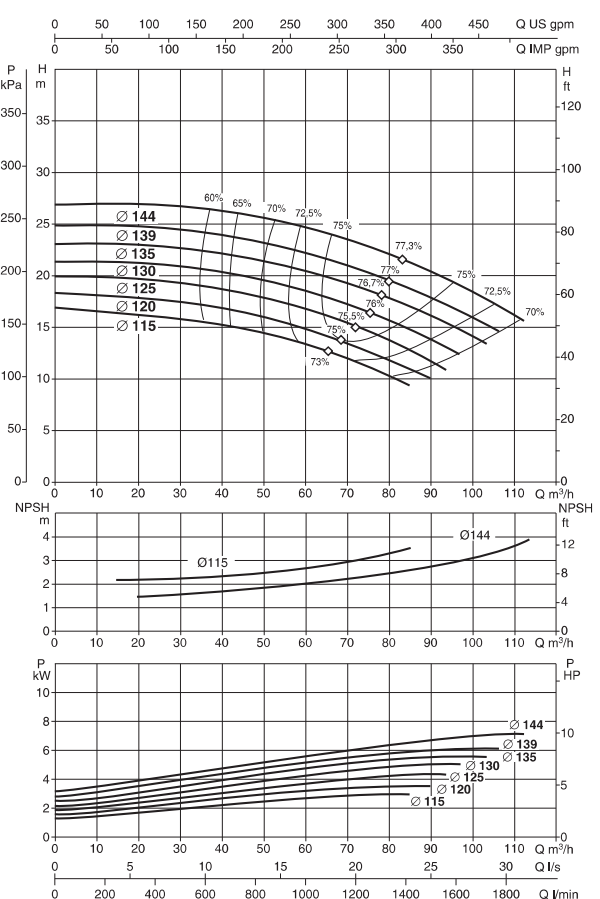

KDN 50-160 = 2900 1/min

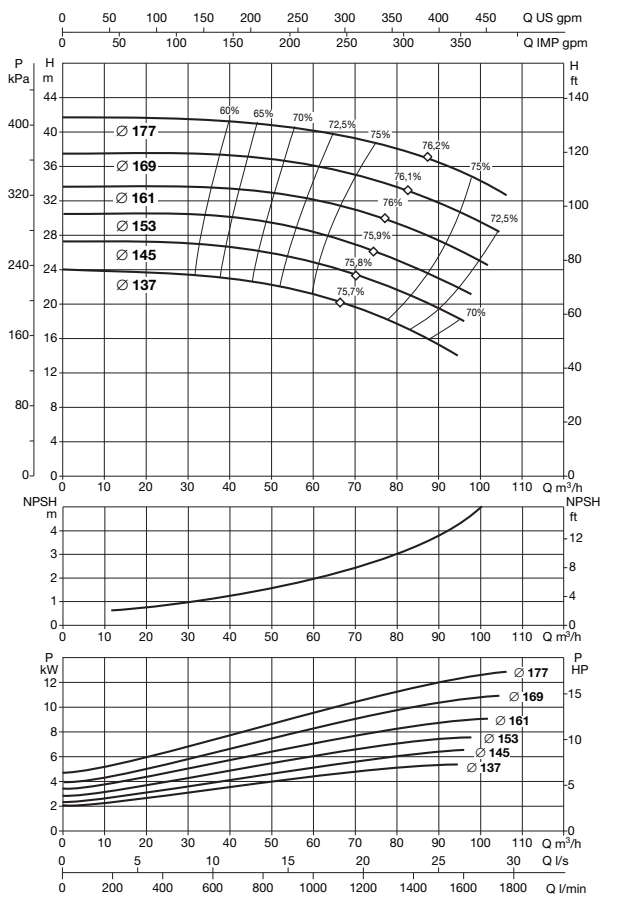

KDN 50-200

= 2900 1/min

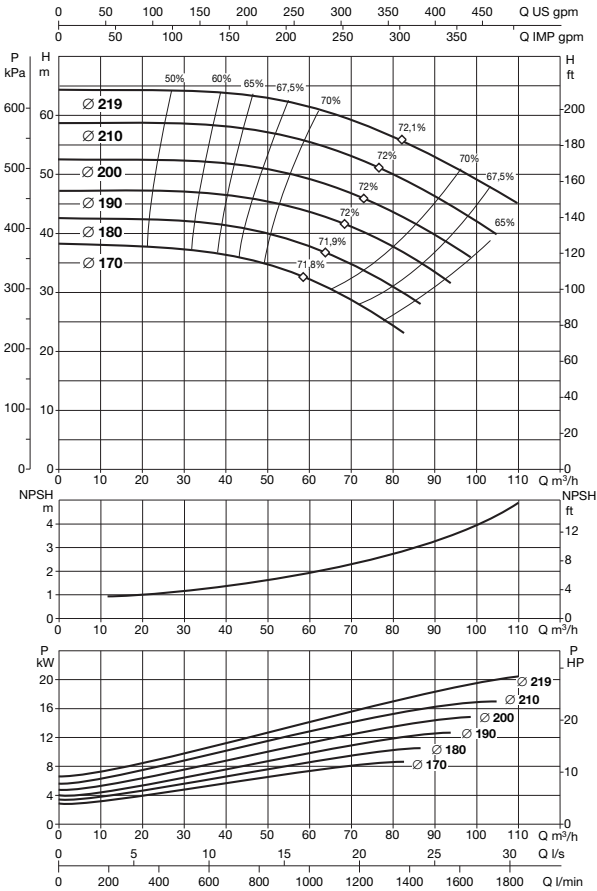

KDN 50-250

= 2900 1/min

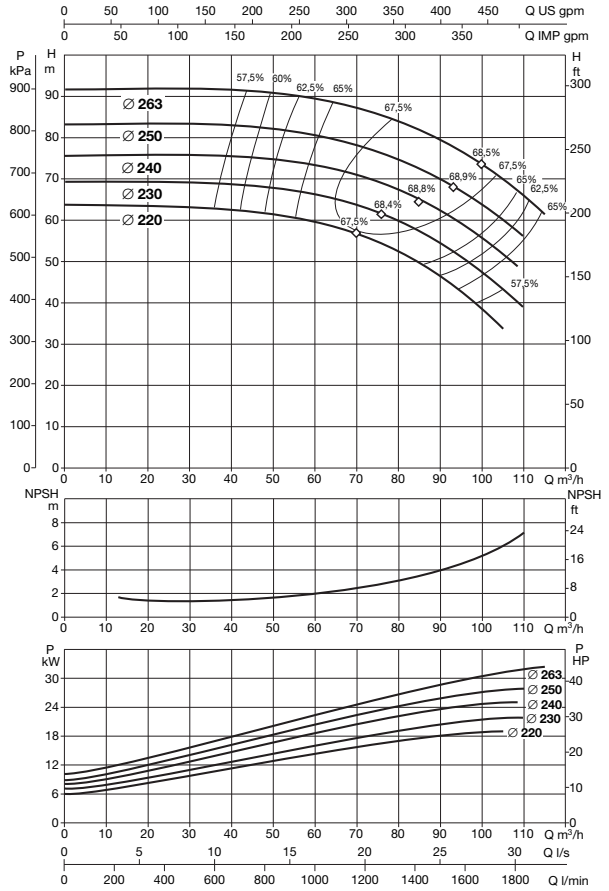

KDN 65-125

= 2900 1/min

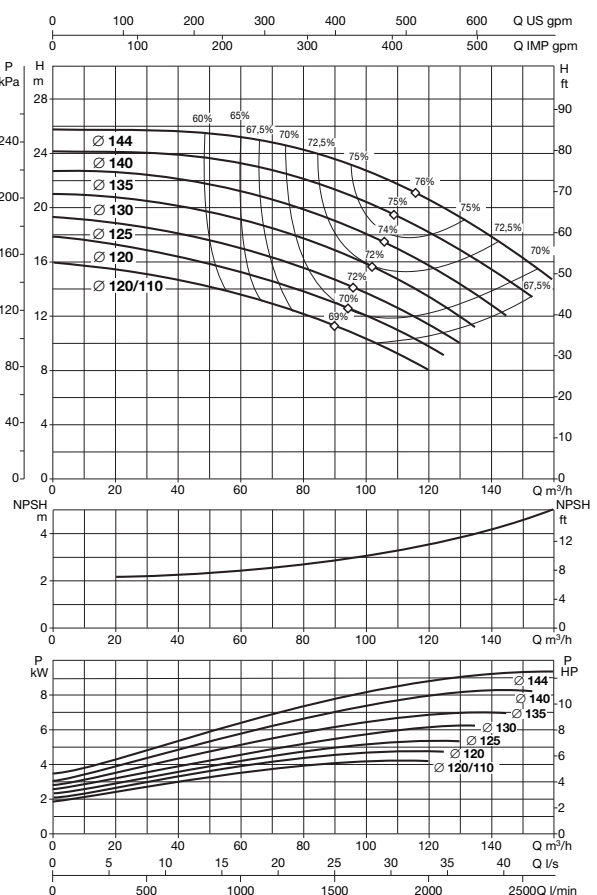

KDN 65-160

= 2900 1/min

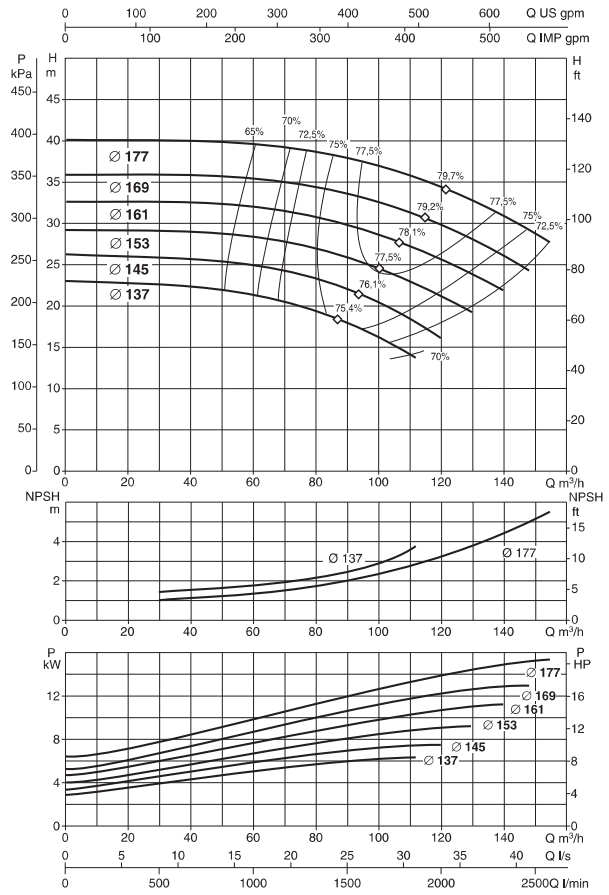

KDN 65-200

= 2900 1/min

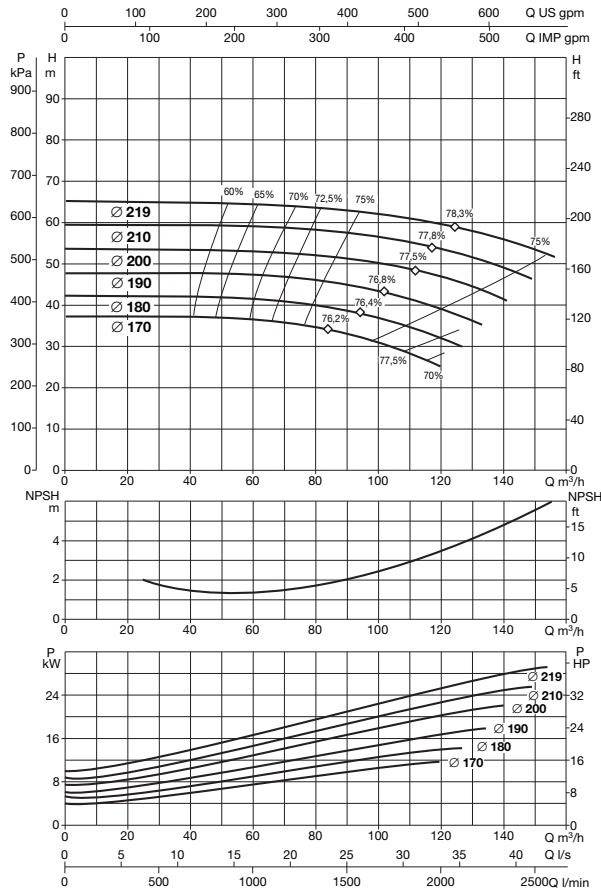

KDN 65-250

= 2900 1/min

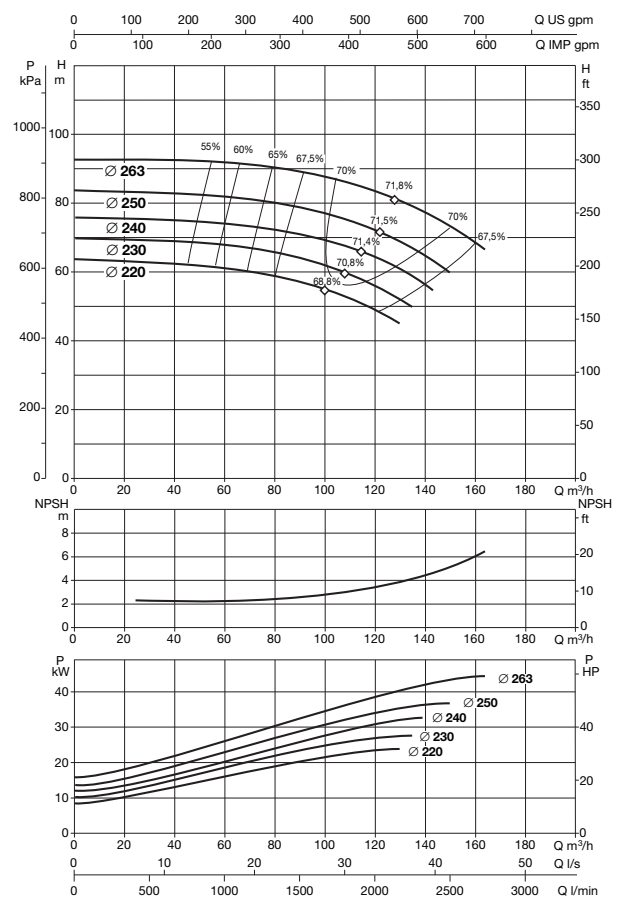

KDN 65-315

= 2900 1/min

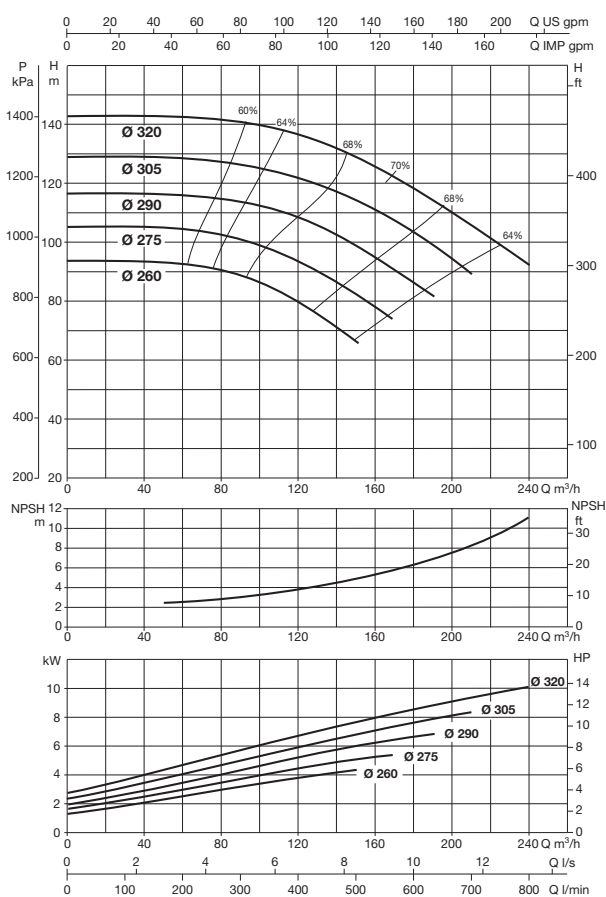

KDN 80-160

= 2900 1/min

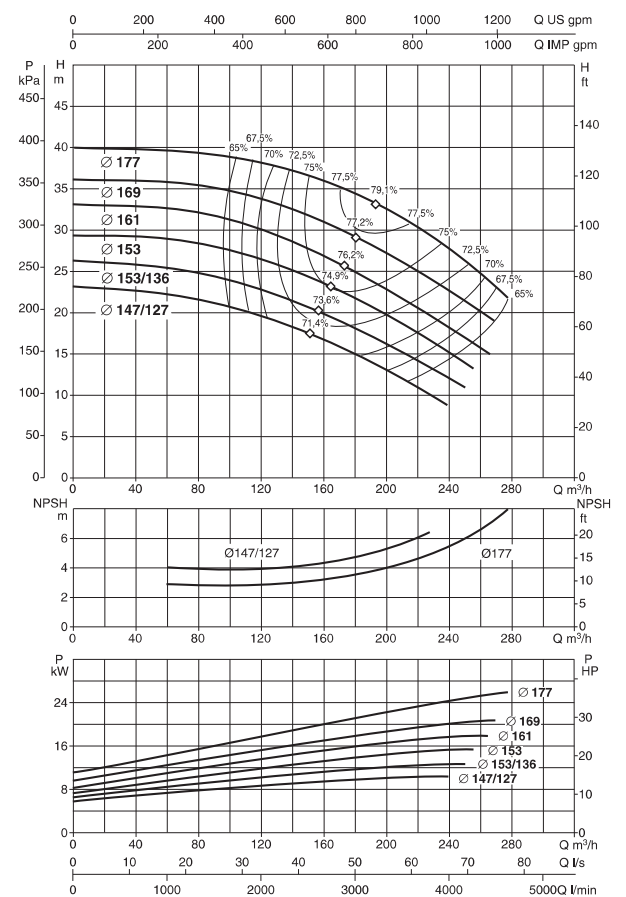

KDN 80-200

= 2900 1/min

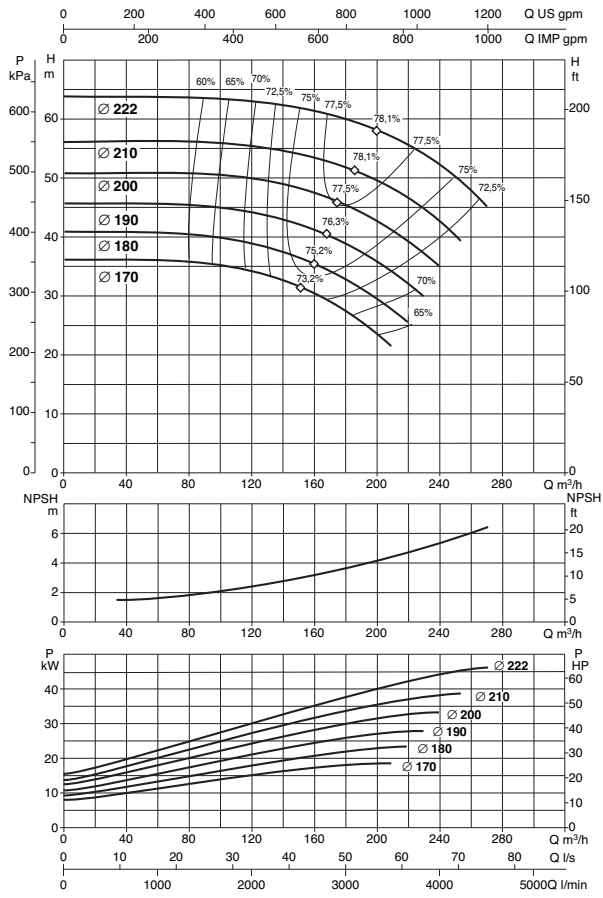

KDN 80-250

= 2900 1/min

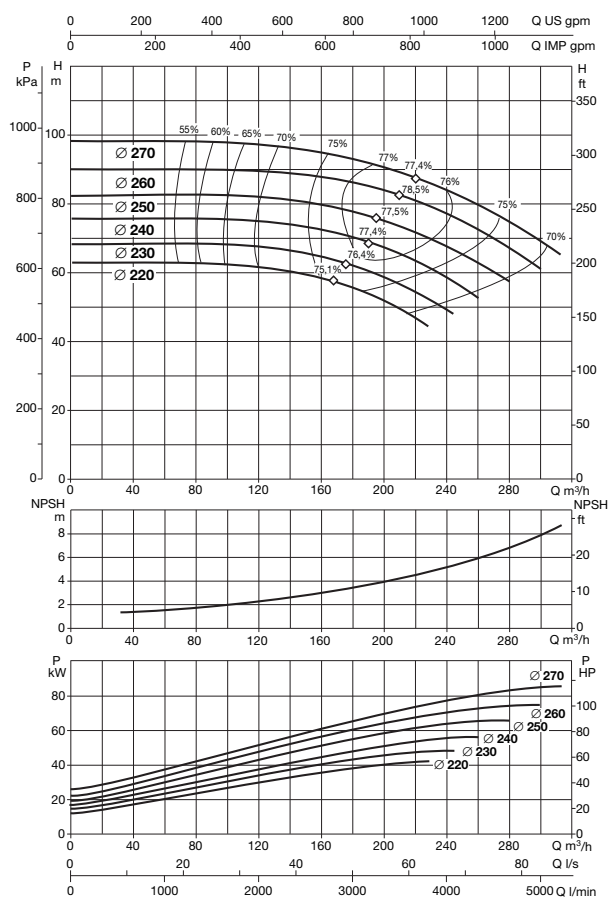

KDN 80-315

= 2900 1/min

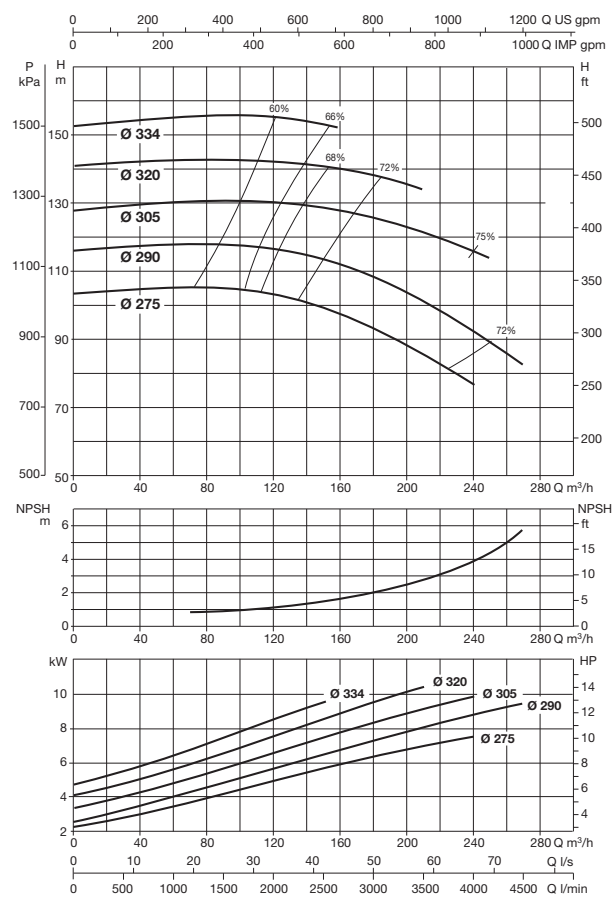

KDN 100-200

= 2900 1/min

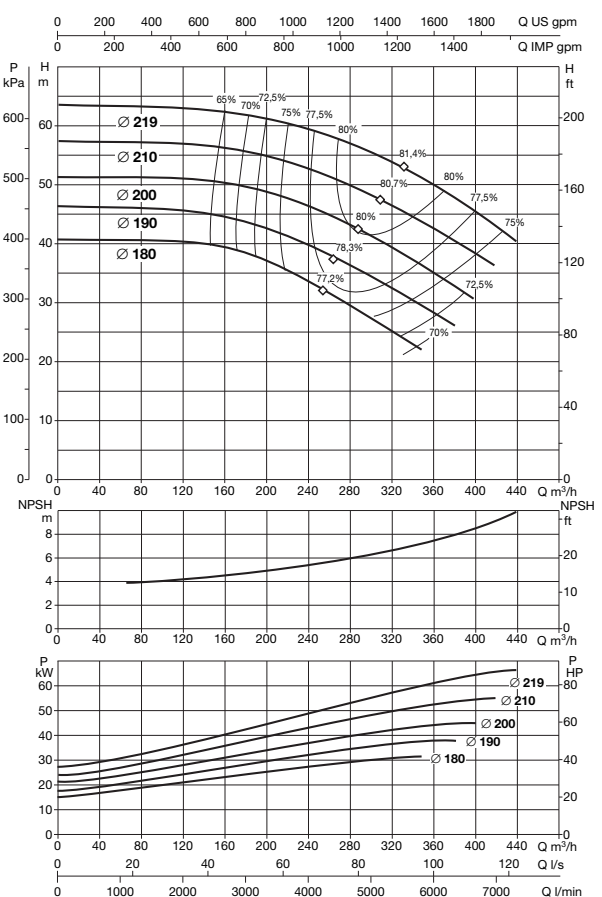

KDN 100-250

= 2900 1/min

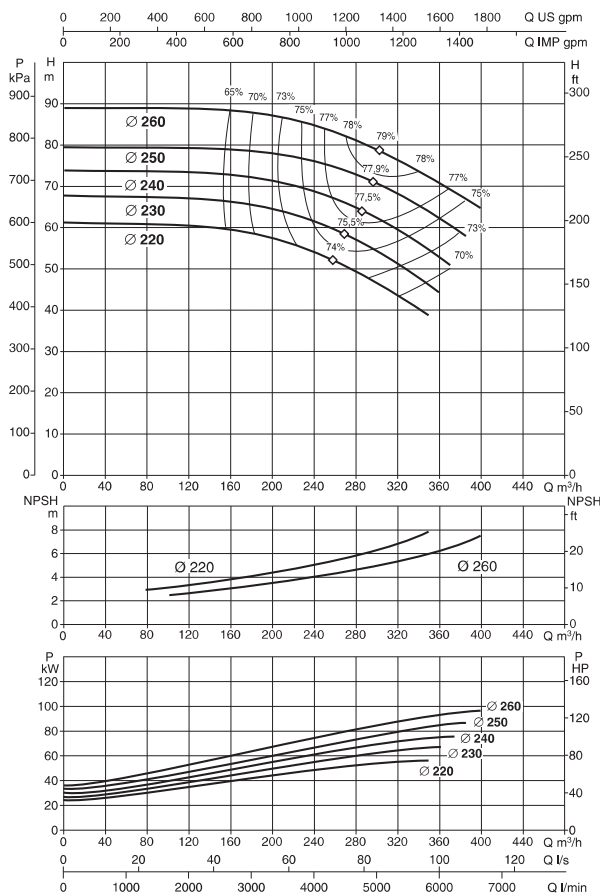

COUNTERFLANGE KIT

Available on request separately from the pump.

The kit comprises intake and delivery counterflanges with the relative gaskets, screws and nuts required by the size of the pump to which it refers.

PARTS	COUNTERFLANGES AND GASKETS	THREADED	TO WELD	MATERIAL	PN
DIN 32	1 X DN 32 + 1 X DN 50	YES	YES	STEEL	16
DIN 40	1 X DN 40 + 1 X DN 65	YES	YES	STEEL	16
DIN 50	1 X DN 50 + 1 X DN 65	YES	YES	STEEL	16
DIN 65	1 X DN 65 + 1 X DN 80	NO	YES	STEEL	16
DIN 80	1 X DN 80 + 1 X DN 100	NO	YES	STEEL	16
DIN 100	1 X DN 100 + 1 X DN 125	NO	YES	STEEL	16
DIN 125	1 X DN 125 + 1 X DN 150	NO	YES	STEEL	16
DIN 150	1 X DN 150 + 1 X DN 200	NO	YES	STEEL	16 (10 X DN 200)
DIN 200	1 X DN 200 + 1 X DN 250	NO	YES	STEEL	16 (10 X DN 200)
DIN 250	1VDN 250 + 1 X DN 300	NO	YES	STEEL	16
DIN 300	1 X DN 300 + 1 X DN 350	NO	YES	STEEL	16

STANDARD MOTORS ELECTRICAL DATA

4 POLES (1500 r.p.m.)

MOTOR TYPE	Power kW	Speed r.p.m.	Efficiency %	Power factor Cos. φ	Supply voltage 50 Hz V~	Nominal current	Starting current Ia/In	Starting torque Ma/Mn	Maximum torque M/k/Mn
MEC 71	0,37	1340	67	0,78	3x230-400	1,70-0,975	4,75	2,84	2,64
MEC 80	0,55	1410	71	0,72	3x230-400	2,60-1,50	5,33	2,78	2,89
MEC 80	0,75	1400	73	0,75	3x230-400	3,30-1,90	5,37	2,9	2,79
MEC 90S	1,1	1390	76	0,8	3x230-400	4,35-2,50	5,92	3,08	2,73
MEC 90L	1,5	1400	78	0,79	3x230-400	6,00-3,45	5,82	3,04	2,81
MEC 100L	2,2	1430	81	0,84	3x230-400	7,95-4,60	6,87	2,35	2,86
MEC 100L	3	1440	83	0,78	3x400 \emptyset	6,7	7,87	3,25	3,53
MEC 112M	4	1440	84	0,84	3x400 \emptyset	8,1	7,57	2,85	3,16
MEC 132S	5,5	1450	86	0,85	3x400 \emptyset	10,6	7,37	2,38	2,93
MEC 132M	7,5	1450	87	0,85	3x400 \emptyset	14,4	7,24	2,47	2,89
MEC 160M	11	1540	88	0,86	3x400 \emptyset	20,8	7,39	2,67	2,76
MEC 160L	15	1450	89	0,89	3x400 \emptyset	27	7,36	2,52	2,66
MEC 180M	18,5	1470	90	0,89	3x400 \emptyset	33	7,48	2,44	3,02
MEC 180L	22	1470	90	0,89	3x400 \emptyset	39	8,15	2,67	3,14
MEC 200L	30	1470	91	0,89	3x400 \emptyset	52,5	7,26	2,93	3,24

2 POLES (3000 r.p.m.)

MOTOR TYPE	Power kW	Speed r.p.m.	Efficiency %	Power factor Cos. φ	Supply voltage 50 Hz V~	Nominal current	Starting current Ia/In	Starting torque Ma/Mn	Maximum torque M/k/Mn
MEC 80	0,75	2820	75	0,83	3x230-400	2,88-1,66	6,06	2,58	2,65
MEC 80	1,1	2820	76,2	0,84	3x230-400	4,00-2,30	6,61	2,4	2,4
MEC 90S	1,5	2820	78,5	0,83	3x230-400	5,75-3,30	7,5	3	2,94
MEC 90L	2,2	2830	81	0,85	3x230-400	7,90-4,55	7,23	3,1	2,85
MEC 100L	3	2860	82,6	0,87	3x400 \emptyset	5,90	7,53	2,67	3
MEC 112M	4	2890	84,2	0,87	3x400 \emptyset	7,80	7,67	2,64	3,16
MEC 132S	5,5	2910	85,7	0,88	3x400 \emptyset	10,4	7,91	2,55	3,27
MEC 132S	7,5	2900	87	0,89	3x400 \emptyset	13,6	7,78	2,3	3,15
MEC 160M	11	2930	88,4	0,9	3x400 \emptyset	19,6	6,57	2,37	2,83
MEC 160M	15	2940	89,4	0,9	3x400 \emptyset	26,5	6,55	2,6	2,89
MEC 160L	18,5	2940	90	0,9	3x400 \emptyset	33,0	7,23	2,82	3,17
MEC 180M	22	2940	90,5	0,9	3x400 \emptyset	39,0	7,41	2,48	3,08
MEC 200L	30	2950	91,4	0,88	3x400 \emptyset	53,5	7,15	2,32	3,05
MEC 200L	37	2970	92	0,89	3x400 \emptyset	64,5	7,87	2,61	3,25
MEC 225M	45	2960	92,5	0,89	3x400 \emptyset	78,0	7,92	2,54	3,19
MEC 250M	55	2980	93	0,9	3x400 \emptyset	94,5	6,17	1,86	2,66
MEC 280S	75	2980	93,6	0,88	3x400 \emptyset	128	6,61	2,27	3,16
MEC 280M	90	2980	93,9	0,89	3x400 \emptyset	160	7,13	2,58	3,34
MEC 315S	110	2980	94	0,89	3x400 \emptyset	188	6,18	2,03	3,05