

 **saci**
pumps

 **PEDROLLO**
GROUP

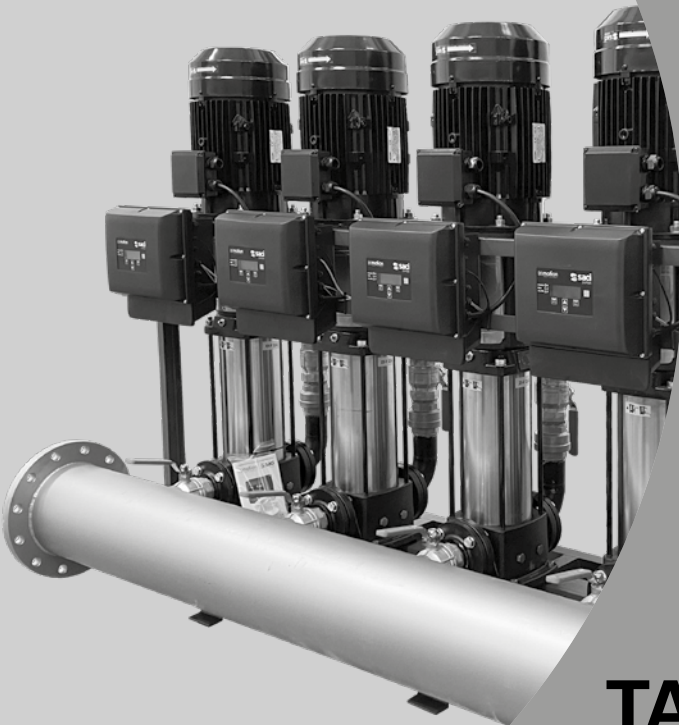
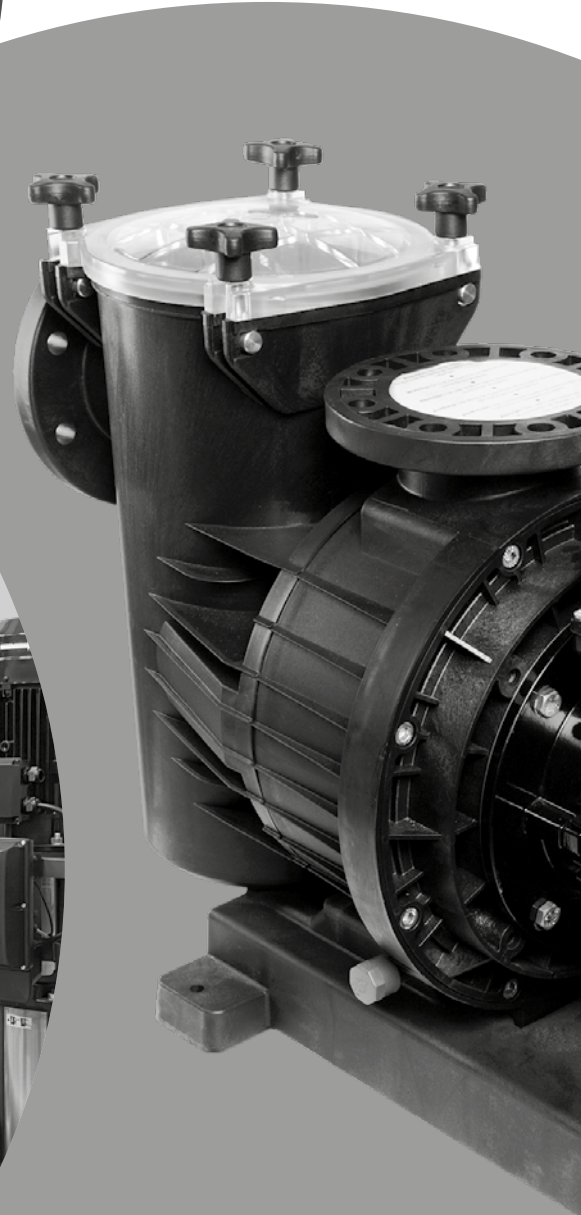

TARIFA 01-2024
PRICE LIST 01-2024

 **saci**
pumps

 **PEDROLLO**
GROUP



	TIPO TYPE	CV HP	PVP € BOMBA/Pump	PVP € BOMBA+SACIPRESS	PVP € BOMBA+AUTOPRESS
--	--------------	----------	---------------------	--------------------------	--------------------------



SIGMA

SIGMA 102 M	0,33	325,00	-	-
SIGMA 103 M	0,5	348,00	429,00	429,00
SIGMA 104 M	0,75	365,00	446,00	446,00
SIGMA 105 M	1	396,00	478,00	478,00
SIGMA 105 T	1	401,00	485,00	-
SIGMA 202 M	1	442,00	-	-
SIGMA 203 M	1	446,00	528,00	528,00
SIGMA 204 M	1,25	488,00	570,00	570,00
SIGMA 205 M	1,5	575,00	657,00	657,00
SIGMA 205 T	1,5	575,00	657,00	-
SIGMA 303 M	1,25	637,00	-	-
SIGMA 303 T	1,25	635,00	-	-
SIGMA 304 M	1,5	691,00	-	-
SIGMA 304 T	1,5	662,00	-	-
SIGMA 305 M	2	775,00	-	-
SIGMA 305 T	2	725,00	-	-
SIGMA 306 T	3	792,00	-	-
SIGMA 307 T	3	826,00	-	-
SIGMA 403 M	2	691,00	-	-
SIGMA 403 T	2	656,00	-	-
SIGMA 404 T	3	739,00	-	-

	TIPO TYPE	CV HP	PVP € BOMBA/Pump
--	--------------	----------	---------------------



JET

JET 82 M	0,8	313,00
JET 82 T	0,8	307,00
JET 102 M	1	368,00
JET 102 T	1	381,00
JET 15 M	1,5	882,00
JET 15 T	1,5	820,00
JET 20 M	2	879,00
JET 25 M	2,5	1.006,00
JET 25 T	2,5	928,00

AP- ASPIRACIÓN PROFUNDA

AP 10.2 M	1	520,00
AP 10.2 T	1	516,00
AP 15 M	1,5	807,00
AP 15 T	1,5	757,00
AP 25 M	2,5	930,00
AP 25 T	2,5	854,00

TIPO
TYPECV
HPPVP €
BOMBA/Pump**PE- PERIFERICAS**

PE 38 M	0,5	224,00
PE 60 M	0,8	268,00
PE 60 T	0,8	268,00

DIVERTECH- SUMERGIBLES DOMÉSTICAS

DIVERTECH 63 M Aut	0,6	625,00
DIVERTECH 103 M Aut	1	684,00
DIVERTECH 103 T	1	642,00
DIVERTECH 153 M Aut	1,5	774,00
DIVERTECH 153 T	1,5	733,00
DIVERTECH HF 154 M Aut	1,5	774,00
DIVERTECH HF 154 T	1,5	733,00
DIVERTECH HF 204 M Aut	2	910,00
DIVERTECH HF 204 T	2	868,00

ANODO DE SACRIFICIO (99,8% ZINC) **70,00****DIVERMATIC- SUMERGIBLES DOMÉSTICAS**

DIVERMATIC 100 M	1	570,00
------------------	---	---------------

NOVA-FEKA-MINI DRX- SUMERGIBLES ACHIQUE

NOVABOX 300 M	0,3	828,00
NOVA SALT M AUT	0,3	350,00

NOVA 180 M	0,3	189,00
NOVA 180 M AUT	0,3	194,00
NOVA 200 M	0,3	238,00
NOVA 300 M AUT	0,3	238,00
NOVA 600 M	0,75	382,00
NOVA 600 M AUT	0,75	356,00
NOVA 600 T	0,75	348,00

FEKA 600 M	0,75	358,00
FEKA 600 M AUT	0,75	348,00
FEKA 600 T	0,75	341,00

MINI DRX M	0,33	283,00
MINI DRX M AUT	0,33	304,00
MINI DRX M AUTFIX	0,33	403,00
DISPOSITIVO ASPIRACIÓN MINI DRX (3mm)		12,00

SUMERGIBLES PARA FUENTES DECORATIVAS Y ACUARIOS

PUMP 400		28,00
PUMP 1150		41,00
PUMP 700		59,00
PUMP 1200		85,00
PUMP 2800		131,00

	TIPO TYPE	CV HP	PVP € Bomba/Pump Optima
--	--------------	----------	-------------------------------



OPTIMA- AUTOASPIRANTES PARA PISCINAS

OPTIMA 25 M	0,25	365,00
OPTIMA 25 T	0,25	370,00
OPTIMA 33 M	0,33	365,00
OPTIMA 33 T	0,33	370,00
OPTIMA 50 M	0,5	388,00
OPTIMA 50 T	0,5	393,00
OPTIMA 75 M	0,75	398,00
OPTIMA 75 T	0,75	422,00
OPTIMA 100 M	1	440,00
OPTIMA 100 T	1	447,00
OPTIMA 150 M	1,5	505,00
OPTIMA 150 T	1,5	512,00

	TIPO TYPE	CV HP	PVP € Bomba/Pump Winner	PVP € con variador with inverter Vario Winner
--	--------------	----------	-------------------------------	--

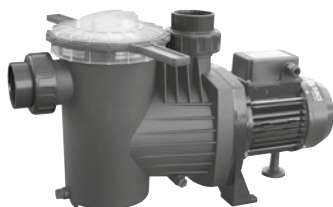

WINNER- AUTOASPIRANTES PARA PISCINAS

WINNER 33 M	0,33	430,00	1.387,00
WINNER 33 T	0,33	457,00	-
WINNER 50 M	0,5	430,00	1.387,00
WINNER 50 T	0,5	457,00	-
WINNER 75 M	0,75	460,00	1.421,00
WINNER 75 T	0,75	491,00	-
WINNER 100 M	1	510,00	1.440,00
WINNER 100 T	1	521,00	-
WINNER 150 M	1,5	554,00	1.494,00
WINNER 150 T	1,5	564,00	-
WINNER 200 M	2	650,00	1.580,00
WINNER 200 T	2	650,00	-
WINNER 300 M	3	764,00	1.630,00
WINNER 300 T	3	700,00	-



KIT SOPORTE PARED [e]JOY

95,00

[e]WINNER- VELOCIDAD VARIABLE CON MOTOR DE IMANES PERMANENTES

[e]WINNER JOY 300 M IE4	MAX 3 HP	1.729,00
[e]WINNER PRO 300 M IE5	MAX 3 HP	1.754,00
SOPORTE PARED VARIADOR		95,00

	TIPO TYPE	CV HP	PVP €
--	--------------	----------	-------



CUADRO ELÉCTRICO PARA BOMBAS DE PISCINA

SMART POOL COMPLETO (PARED / WALL)	277,00
SMART POOL PRO (PARED / WALL)	401,00
CUADRO (PANEL) FOCOS LED 50W	151,00
CUADRO (PANEL) FOCOS LED 2x50W	191,00
SONDA (PROBE) TEMPERATURA PT-100 1/4" AISI 316	77,00

	TIPO TYPE	CV HP	PVP € Bomba/Pump	PVP € con variador/with inverter Vario Supra
--	--------------	----------	---------------------	--



SUPRA- AUTOASPIRANTES PARA PISCINAS

SUPRA 300 M		3	1.230,00	-
SUPRA 300		3	1.119,00	2.198,00
SUPRA 400		4	1.197,00	2.276,00
SUPRA 550		5,5	1.430,00	2.509,00

	TIPO TYPE	CV HP	PVP € Bomba/Pump Magnus	PVP € con variador with inverter Vario Magnus
--	--------------	----------	-------------------------------	--



MAGNUS- AUTOASPIRANTES PARA PISCINAS

MAGNUS-4 250		2,5	1.469,00	2.565,00
MAGNUS-4 300		3	1.469,00	2.565,00
MAGNUS-4 400		4	1.505,00	2.601,00
MAGNUS-4 550		5,5	1.694,00	2.790,00
MAGNUS-4 550 (R. Bronce)		5,5	2.239,00	3.335,00
MAGNUS-4 750		7,5	2.275,00	4.447,00
MAGNUS-4 750 (R. Bronce)		7,5	2.714,00	4.886,00
MAGNUS-4 1000		10	2.441,00	4.613,00
MAGNUS-4 1000 (R. Bronce)		10	2.868,00	5.040,00
MAGNUS-2 1250		12,5	2.913,00	5.085,00
MAGNUS-2 1500		15	2.958,00	5.130,00

BOMBAS A 1.450RPM EXCEPTO
MODELOS DE 12,5CV Y 15CV
PUMPS AT 1,450RPM EXCEPT
THE 12,5HP AND 15HP TYPES

KIT CONTRABRIDAS PVC DN-110

140,00

* Las bombas VARIO MAGNUS incorporan el variador [e]POOL TT3
* The VARIO MAGNUS pumps includes the [e]POOL TT3 inverter

	TIPO TYPE	CV HP	PVP € Bomba Pump
--	--------------	----------	------------------------



[e]MAGNUS BOMBA PISCINA VELOCIDAD VARIABLE CON MOTOR DE IMANES PERMANENTES



[e]MAGNUS-4 550		5,5	3.704,00
[e]MAGNUS-4 550 (ROD. BRONCE)		5,5	4.237,00
SOPORTE PARED VARIADOR			95,00

	TIPO TYPE	CV HP	PVP € con variador with inverter Vario Magnus
--	--------------	----------	--





VERT MAGNUS- AUTOASPIRANTES PARA PISCINAS

VERT MAGNUS-4 250		2,5	5.077,00
VERT MAGNUS-4 300		3	5.077,00
VERT MAGNUS-4 400		4	5.126,00
VERT MAGNUS-4 550		5,5	5.323,00
VERT MAGNUS-4 550 (R. Bronce)		5,5	5.795,00
VERT MAGNUS-4 750		7,5	5.554,00
VERT MAGNUS-4 750 (R. Bronce)		7,5	6.030,00
VERT MAGNUS-4 1000		10	5.779,00
VERT MAGNUS-4 1000 (R. Bronce)		10	6.263,00
VERT MAGNUS-2 1250		12,5	6.364,00
VERT MAGNUS-2 1500		15	6.420,00





TIPO TYPE	CV HP	PVP € CF-2	PVP € VERT CF-2 (Vertical)
CF-2- 2,900 RPM			
CF-2 300 (2.900 r.p.m.)	3	2.365,00	3.815,00
CF-2 400 (2.900 r.p.m.)	4	2.576,00	3.928,00
CF-2 550 (2.900 r.p.m.)	5,5	3.072,00	4.360,00
CF-2 551 (2.900 r.p.m.)	5,5	3.079,00	4.372,00
CF-2 750 (2.900 r.p.m.)	7,5	3.457,00	4.782,00
CF-2 1000 (2.900 r.p.m.)	10	3.685,00	5.193,00
CF-2 1250 (2.900 r.p.m.)	12,5	4.148,00	5.525,00
CF-2 1500 (2.900 r.p.m.)	15	4.355,00	5.742,00



TIPO TYPE	CV HP	PVP € HF-2	PVP € VERT HF-2 (Vertical)
HF-2- GRAN ALTURA A 2,900 RPM			
HF-2 308 (2.900 r.p.m.)	3	2.973,00	4.419,00
HF-2 408 (2.900 r.p.m.)	4	3.162,00	4.609,00
HF-2 558 (2.900 r.p.m.)	5,5	3.292,00	4.708,00
HF-2 758 (2.900 r.p.m.)	7,5	4.008,00	5.363,00
HF-2 1008 (2.900 r.p.m.)	10	4.419,00	5.688,00
HF-2 1208 (2.900 r.p.m.)	10	4.381,00	5.672,00
HF-2 1508 (2.900 r.p.m.)	15	5.247,00	6.455,00
HF-2 2008 (2.900 r.p.m.)	20	5.567,00	6.784,00
HF-2 2508 (2.900 r.p.m.)	25	5.868,00	6.982,00

NO EQUIPAN CONTRABRIDAS / COUNTERFLANGES NOT INCLUDED

TIPO TYPE	CV HP	PVP € CF-4	PVP € VERT CF-4 (Vertical)
CF-4- 1,450 RPM			
CF-4 300 (1.450 r.p.m.)	3	3.276,00	4.827,00
CF-4 400 (1.450 r.p.m.)	4	3.657,00	5.220,00
CF-4 550 (1.450 r.p.m.)	5,5	3.830,00	5.401,00
CF-4 552 (1.450 r.p.m.)	5,5	4.245,00	5.806,00
CF-4 750 (1.450 r.p.m.)	7,5	4.554,00	6.130,00
CF-4 1000 (1.450 r.p.m.)	10	5.262,00	6.864,00
CF-4 1500 (1.450 r.p.m.)	15	6.761,00	8.105,00
CF-4 2000 (1.450 r.p.m.)	20	7.826,00	8.670,00
CF-4 2500 (1.450 r.p.m.)	25	8.540,00	9.263,00

NO EQUIPAN CONTRABRIDAS / COUNTERFLANGES NOT INCLUDED

TIPO TYPE	CV HP	PVP € HF-4	PVP € VERT HF-4 (Vertical)
HF-4- GRAN ALTURA A 1,450 RPM			
HF-4 308 (1.450 r.p.m.)	3	3.792,00	5.239,00
HF-4 408 (1.450 r.p.m.)	4	3.843,00	5.290,00
HF-4 558 (1.450 r.p.m.)	5,5	4.125,00	5.572,00
HF-4 758 (1.450 r.p.m.)	7,5	5.152,00	6.595,00
HF-4 1008 (1.450 r.p.m.)	10	6.011,00	7.454,00
HF-4 1508 (1.450 r.p.m.)	15	7.038,00	8.131,00
HF-4 2008 (1.450 r.p.m.)	20	7.452,00	8.665,00
HF-4 2508 (1.450 r.p.m.)	25	8.510,00	9.553,00
HF-4 3008 (1.450 r.p.m.)	30	8.886,00	9.734,00

NO EQUIPAN CONTRABRIDAS / COUNTERFLANGES NOT INCLUDED

	TIPO TYPE	PVP €
--	--------------	-------



VARIADORES DE FRECUENCIA PARA BOMBAS DE PISCINA

VARIADOR DE VELOCIDAD [e]JOY (MT2)	798,00
VARIADOR DE VELOCIDAD [e]JOY (TT3-11)	1.015,00
VARIADOR DE VELOCIDAD [e]POOL (TT3-11)	997,00
VARIADOR DE VELOCIDAD [e]POOL (TT3-30)	1.975,00
SONDA TEMPERATURA NTC 47K B=4000 1/4" AISI 316	84,00
SOPORTE PARED VARIADOR [e]JOY - [e]POOL	95,00

TIPO TYPE	Conexiones Connections	PVP € Hierro/Cast iron	PVP € Bronce/Bronze
--------------	---------------------------	---------------------------	------------------------



PREFILTROS COMPLETOS HIERROY BRONCE

F 65 / 65	DN-65	918,00	-
F 80 / 80	DN-80	918,00	CONSULTAR
F 100 / 100	DN-100	992,00	-
F 125 / 125	DN-125	992,00	CONSULTAR
F 150 / 150	DN-150	2.060,00	-
F 200 / 200	DN-200	2.089,00	-



V 65/65	DN-65	2.415,00	-
V 80/80	DN-80	2.415,00	-
V 100/100	DN-100	2.568,00	-
V 125/125	DN-125	2.568,00	-
V 150/150	DN-150	2.568,00	-

TIPO TYPE	Conexiones Connections	PVP €
--------------	---------------------------	-------



PREFILTROS SUELTOS ACERO INOX. AISI 316L

IH 65 / 65	DN-65	CONSULTAR
IH 80 / 80	DN-80	CONSULTAR
IH 100 / 100	DN-100	CONSULTAR
IH 125 / 125	DN-125	CONSULTAR
IH 150 / 150	DN-150	CONSULTAR
IH 200 / 200	DN-200	CONSULTAR

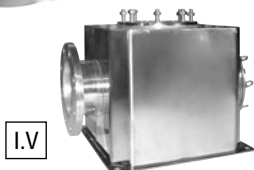

IV 100 / 65 VERT	DN 100-65	CONSULTAR
IV 100 / 80 VERT	DN 100-80	CONSULTAR
IV 125 / 100 VERT	DN 125-100	CONSULTAR
IV 150 / 125 VERT	DN 150-125	CONSULTAR
IV 200 / 150 VERT	DN 250-150	CONSULTAR



2.900 r.p.m.

TIPO TYPE	CV HP	PVP € Motor IE-3
BR-2- CENTRIFUGAS EN BRONCE MARINO		
BR-2 300	3	CONSULTAR
BR-2 400	4	CONSULTAR
BR-2 550	5,5	CONSULTAR
BR-2 551	5,5	CONSULTAR
BR-2 750	7,5	CONSULTAR
BR-2 1000	10	CONSULTAR
BR-2 1250	12,5	CONSULTAR
BR-2 1500	15	CONSULTAR



POOLMATIC BOMBAS LIMPIAFONDOS AUTOMÁTICO

TIPO TYPE	CV HP	PVP € Monof/Single ph	PVP € Trif/Three ph
POOLMATIC 30 / 50	0,75	525,00	480,00
POOLMATIC 40 / 50	1	613,00	611,00

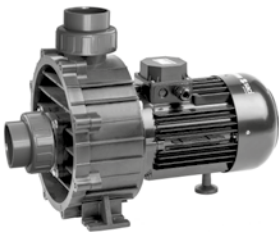

BRAVUS- CENTRIFUGAS CONTRA CORRIENTE

TIPO TYPE	CV HP	PVP € Bomba/Pump Bravus	PVP € con variador with inverter Vario Bravus
BRAVUS 300 M - 2900 RPM	3	1.125,00	-
BRAVUS 300 T - 2900 RPM	3	1.022,00	2.101,00
BRAVUS 400 T - 2900 RPM	4	1.107,00	2.186,00
BRAVUS 550 T - 2900 RPM	5,5	1.331,00	2.410,00



KONTRA- CENTRIFUGAS DE GRAN CAUDAL (CONTRACORRIENTE)

TIPO TYPE	CV HP	PVP € Bomba/Pump Kontra	PVP € con variador with inverter Vario Kontra
KONTRA-4 250	2,5	1.236,00	2.332,00
KONTRA-4 300	3	1.236,00	2.332,00
KONTRA-4 400	4	1.275,00	2.371,00
KONTRA-4 550	5,5	1.512,00	2.608,00
KONTRA-4 550 (ROD. BRONCE)	5,5	1.997,00	3.093,00
KONTRA-4 750	7,5	2.031,00	4.203,00
KONTRA-4 750 (ROD.BRONCE)	7,5	2.561,00	4.733,00
KONTRA-4 1000	10	2.178,00	4.350,00
KONTRA-4 1000 (ROD. BRONCE)	10	2.607,00	4.779,00
KONTRA-2 1250	12,5	2.652,00	4.824,00
KONTRA-2 1500	15	2.697,00	4.869,00
KIT CONTRABRIDAS PVC DN-110		140,00	

BOMBAS A 1.450RPM EXCEPTO MODELOS DE 12,5CV Y 15CV
PUMPS AT 1,450RPM EXCEPT THE 12,5HP AND 15HP TYPES

* Las bombas VARIO KONTRA incorporan el variador [e]POOL TT3
* The VARIO KONTRA pumps includes the [e]POOL TT3 inverter



FILTROS LAMINADOS PISCINA PRIVADA

TIPO TYPE	Ø exterior	Caudal flow lts/h	Ø Ent. Ø Sal.	PVP € Valv. Lateral	PVP € Valv. TOP
SUN 400	400	6.500	1 1/2"	628,00	533,00
SUN 510	510	10.200	1 1/2"	695,00	609,00
SUN 620	620	15.100	1 1/2"	769,00	686,00
SUN 680	680	18.140	1 1/2"	1.082,00	923,00
SUN 750	750	22.000	2"	1.121,00	-
SUN 900	900	31.800	2"	1.439,00	-

Filtros de alto rendimiento. No incluyen arena.
High performance filters. Sand not included.



No incluyen batería de válvulas. Lecho filtrante de 1 metro. Incluye brazo colector. Bajo demanda 1,2 mts lecho y placa crepinás.
Battery valves not included. Filtration bed of 1 meter. Includes arm collector. Under demand 1,2 meters of filtration bed and/or Noozle plate.

FILTROS LAMINADOS PISCINA PÚBLICA

TIPO TYPE	20 m³/h/m² PVP €	30 m³/h/m² PVP €	40 m³/h/m² PVP €	50 m³/h/m² PVP €
SUN 1050	3.184,00	3.279,00	3.279,00	3.445,00
SUN 1200	-	3.646,00	3.646,00	3.760,00
SUN 1400	3.819,00	4.024,00	4.574,00	4.574,00
SUN 1600	4.932,00	5.137,00	5.137,00	5.549,00
SUN 1800	6.531,00	6.824,00	7.338,00	7.412,00
SUN 2000	8.516,00	8.797,00	9.460,00	9.649,00

SUPLEMENTO BOCA DE HOMBRE
SUPLEMENTO MIRILLA

1.561,00
625,00

FILTROS LAMINADOS ALTO RENDIMIENTO

High performance Laminated Filters



TIPO TYPE	20 m³/h/m² PVP €	30 m³/h/m² PVP €	40 m³/h/m² PVP €	50 m³/h/m² PVP €
FILTRO AR. LAM. SUN D.1050	4.374,00	4.701,00	4.701,00	4.936,00
FILTRO AR. LAM. SUN D.1200	-	5.842,00	5.842,00	5.642,00
FILTRO AR. LAM. SUN D.1400	5.984,00	6.573,00	7.022,00	7.022,00
FILTRO AR. LAM. SUN D.1600	7.510,00	7.824,00	7.824,00	8.163,00
FILTRO AR. LAM. SUN D.1800	9.212,00	9.627,00	10.351,00	10.506,00
FILTRO AR. LAM. SUN D.2000	10.802,00	11.164,00	12.004,00	12.244,00

BATERÍAS DE 5 VALVULAS



TIPO TYPE	PVP €
BATERÍA 5 VALVULAS DN 75	1.683,00
BATERÍA 5 VALVULAS DN 90	2.009,00
BATERÍA 5 VALVULAS DN 110	2.244,00
BATERÍA 5 VALVULAS DN 125	2.688,00
BATERÍA 5 VALVULAS DN 140	2.941,00
BATERÍA 5 VALVULAS DN 160	3.910,00
BATERÍA 5 VALVULAS DN 200	5.357,00

BOMBAS DOSIFICADORAS

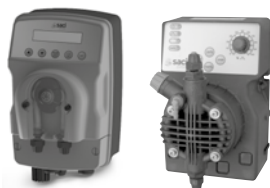

PL 23	398,00
PL 50	649,00
PL 75	677,00
DOSING KIT PH 1,5 lts a 1,5 bar	850,00
DOSING KIT RX 1,5 lts a 1,5 bar	850,00

	TIPO TYPE	CV HP	PVP € Monof/ Single ph	PVP € Trif/ Three ph
--	--------------	----------	---------------------------	-------------------------

BOMBAS SOPLANTES



BLOWER 80-400	0,6	629,00	629,00
BLOWER 140-850	1,2	788,00	788,00
BLOWER 140-131	1,8	841,00	841,00
BLOWER 210-131	1,8	924,00	924,00
BLOWER 210-151	2	1.020,00	-
BLOWER 210-161	2,2	-	980,00
BLOWER 315-221	3	-	1.429,00
BLOWER 315-301	4	-	1.596,00



	TIPO TYPE	PVP €
--	--------------	-------

A. CASCADA ALDARA MINI		1.480,00
B. CASCADA ALDARA		2.414,00
C. CASCADA RIMINI		2.164,00



A



B



C

	TIPO TYPE	CV HP	PVP € Monof/Single ph	PVP € Trif/Three ph
--	--------------	----------	--------------------------	------------------------



V-NOX

V-NOX 303	1,25	674,00	618,00
V-NOX 304	1,5	695,00	658,00
V-NOX 305	2	726,00	687,00
V-NOX 306	3	-	736,00
V-NOX 307	3	-	819,00
V-NOX 308	4	-	967,00
V-NOX 309	4	-	1.003,00
V-NOX 310	5,5	-	1.067,00
V-NOX 403	2	720,00	673,00
V-NOX 404	3	-	742,00
V-NOX 405	4	-	967,00
V-NOX 406	4	-	1.015,00
V-NOX 407	5,5	-	1.109,00



[e]NOX- BOMBA CON VARIADOR DE FRECUENCIA Y MOTOR DE IMANES PERMANENTES

[e]NOX 306 M	3	1.793,00	-
[e]NOX 310 T	5,5	-	2.127,00
[e]NOX 407 T	5,5	-	2.110,00

	TIPO TYPE	CV HP	PVP € Motor IE-3
--	--------------	----------	---------------------

VAT



VAT 127L-6	3	1.304,00
VAT 127L-7	3	1.351,00
VAT 127L-8	3	1.389,00
VAT 127L-9	4	1.524,00
VAT 127L-10	4	1.561,00
VAT 127L-11	5,5	1.688,00
VAT 127L-12	5,5	1.725,00
VAT 127L-13	5,5	1.762,00
VAT 163L-3	4	1.904,00
VAT 163L-4	5,5	2.066,00
VAT 163L-5	7,5	2.401,00
VAT 163L-6	7,5	2.476,00
VAT 163L-7	10	2.746,00
VAT 163L-8	10	2.823,00
VAT 163L-9	12,5	3.467,00
VAT 205-3	12,5	4.515,00
VAT 205-4	20	5.087,00
VAT 205-5	20	5.388,00
VAT 205-6	25	5.944,00

	TIPO TYPE	CV HP	PVP € Motor IE-3
--	--------------	----------	---------------------

XV-F- AISI 304



Sello mecánico
Mechanical seal

XV-F 5-8	1,5	843,00
XV-F 5-8 Monofásica	1,5	895,00
XV-F 5-10	2	948,00
XV-F 5-10 Monofásica	2	1.048,00
XV-F 5-14	3	1.117,00
XV-F 5-16	3	1.170,00
XV-F 5-20	4	1.464,00
XV-F 5-29	5,5	1.825,00
XV-F 5-36	7,5	2.326,00
XV-F 10-6	3	1.148,00
XV-F 10-9	4	1.490,00
XV-F 10-10	5,5	1.637,00
XV-F 10-12	5,5	1.734,00
XV-F 10-16	7,5	2.291,00
XV-F 10-22	10	2.785,00
XV-F 15-5	5,5	1.563,00
XV-F 15-7	7,5	2.079,00
XV-F 15-9	10	2.437,00
XV-F 15-14	15	3.400,00
XV-F 15-17	20	3.916,00
XV-F 20-5	7,5	2.022,00
XV-F 20-7	10	2.415,00
XV-F 20-10	15	3.256,00
XV-F 20-14	20	3.706,00
XV-F 20-17	25	4.209,00
XV-F 32-3	7,5	2.563,00
XV-F 32-4	10	2.961,00
XV-F 32-6	15	3.981,00
XV-F 32-8	20	4.540,00
XV-F 32-10	25	5.166,00
XV-F 32-12	30	6.089,00
XV-F 32-14	40	7.570,00
XV-F 45-2	10	2.821,00
XV-F 45-3	15	3.813,00
XV-F 45-4	20	4.157,00
XV-F 45-5	25	4.650,00
XV-F 45-6	30	5.449,00
XV-F 45-9-2	40	7.387,00
XV-F 45-10	50	7.902,00
XV-F 45-13-2	60	9.374,00
XV-F 64-2	15	3.656,00
XV-F 64-3-1	20	4.140,00
XV-F 64-4-2	25	4.669,00
XV-F 64-4	30	5.262,00
XV-F 64-6-2	40	6.951,00
XV-F 64-7-1	50	7.500,00
XV-F 64-8-1	60	8.632,00
XV-F 90-2-2	15	3.863,00
XV-F 90-2	20	4.123,00
XV-F 90-3-2	25	4.692,00
XV-F 90-3	30	5.426,00
XV-F 90-4	40	6.940,00
XV-F 90-5	50	7.621,00
XV-F 90-6	60	8.747,00

* Estas bombas no equipan contrabridas de serie. Precios de las contrabridas en la página siguiente.

* Counterflanges are not equipped as standard. See the prices on next page.

	TIPO TYPE	CV HP	PVP € Motor IE-3
--	--------------	----------	---------------------

XV-F- AISI 304



* Estas bombas no equipan contrabridas de serie.
* Counterflanges are not equipped as standard.

XV-F 120-1	15	7.098,00
XV-F 120-2-1	25	8.899,00
XV-F 120-2	30	9.454,00
XV-F 120-3	40	12.060,00
XV-F 120-4-1	50	13.419,00
XV-F 120-5-1	60	15.213,00
XV-F 120-6-1	75	19.155,00
XV-F 120-7	100	23.256,00
XV-F 150-1-1	15	7.129,00
XV-F 150-1	20	7.484,00
XV-F 150-2-1	30	9.369,00
XV-F 150-3-2	40	12.180,00
XV-F 150-3	50	12.491,00
XV-F 150-4-1	60	14.345,00
XV-F 150-5-2	75	18.323,00
XV-F 150-6	100	22.459,00

XV-F - KITS CONTRABRIDAS PARA BOMBAS



KIT BRIDAS XV-F DN 32 (PN 10) (ROSCADA)	176,00
KIT BRIDAS XV-F DN 32 (PN 16) (PLANA SOLD)	94,00
KIT BRIDAS XV-F DN 32 (PN 40) (CUELLO SOLD)	157,00
KIT BRIDAS XV-F DN 40 (PN 10) (ROSCADA)	194,00
KIT BRIDAS XV-F DN 40 (PN 16) (PLANA SOLD)	106,00
KIT BRIDAS XV-F DN 40 (PN 40) (CUELLO SOLD)	189,00
KIT BRIDAS XV-F DN 50 (PN 10) (ROSCADA)	257,00
KIT BRIDAS XV-F DN 50 (PN 16) (PLANA SOLD)	125,00
KIT BRIDAS XV-F DN 50 (PN 40) (CUELLO SOLD)	218,00
KIT BRIDAS XV-F DN 65 (PN 10) (ROSCADA)	305,00
KIT BRIDAS XV-F DN 65 (PN 16) (PLANA SOLD)	152,00
KIT BRIDAS XV-F DN 65 (PN 40) (CUELLO SOLD)	259,00
KIT BRIDAS XV-F DN 80 (PN 16) (PLANA SOLD)	194,00
KIT BRIDAS XV-F DN 80 (PN 40) (CUELLO SOLD)	344,00
KIT BRIDAS XV-F DN 100 (PN 16) (PLANA SOLD)	206,00
KIT BRIDAS XV-F DN 100 (PN 40) (CUELLO SOLD)	436,00
KIT BRIDAS XV-F DN 125 (PN 16) (PLANA SOLD)	260,00
KIT BRIDAS XV-F DN 125 (PN 40) (CUELLO SOLD)	677,00

* Bridas de Hierro
* Iron Flanges

	TIPO TYPE	CV HP	PVP € Motor IE-3
--	--------------	----------	---------------------



XVN-F- AISI 316

XVN-F 1/7	0,5	1.263,00
XVN-F 1/11	0,75	1.404,00
XVN-F 1/15	1	1.643,00
XVN-F 1/22	1,5	1.834,00
XVN-F 1/30	2	2.203,00
XVN-F 1/40	3	2.562,00
XVN-F 3/6	0,75	1.275,00
XVN-F 3/8	1	1.475,00
XVN-F 3/12	1,5	1.619,00
XVN-F 3/16	2	1.962,00
XVN-F 3/23	3	2.169,00
XVN-F 3/31	4	2.615,00
XVN-F 5/8	1,5	1.534,00
XVN-F 5/11	2	1.779,00
XVN-F 5/16	3	2.009,00
XVN-F 5/21	4	2.379,00
XVN-F 5/28	5,5	2.849,00
XVN-F 5/33	7,5	3.682,00
XVN-F 10/6	3	2.214,00
XVN-F 10/8	4	2.524,00
XVN-F 10/11	5,5	3.011,00
XVN-F 10/15	7,5	4.050,00
XVN-F 10/21	10	4.409,00
XVN-F 10/22	15	5.529,00
XVN-F 15/3	4	2.250,00
XVN-F 15/5	5,5	2.678,00
XVN-F 15/7	7,5	3.539,00
XVN-F 15/9	10	3.799,00
XVN-F 15/14	15	5.276,00
XVN-F 15/18	20	5.870,00
XVN-F 20/5	7,5	3.511,00
XVN-F 20/7	10	3.751,00
XVN-F 20/10	15	5.139,00
XVN-F 20/14	20	5.870,00
XVN-F 20/17	25	6.374,00
XVN-F 32/3	7,5	4.652,00
XVN-F 32/4	10	4.980,00
XVN-F 32/6	15	5.814,00
XVN-F 32/8	20	6.900,00
XVN-F 32/10	25	7.932,00
XVN-F 32/12	30	9.661,00
XVN-F 32/16	40	13.628,00

* No equipan contrabridas de serie (consultar precio).

* Counterflanges not included (request prices).

	TIPO TYPE	CV HP	PVP € BOMBA/Pump
--	--------------	----------	---------------------

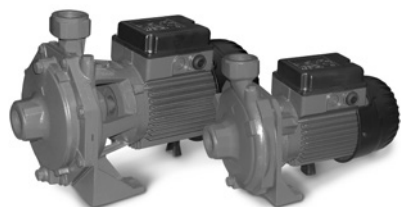
K

K 5 M	0,5	403,00
K 5 T	0,5	381,00
K 8 M	1	530,00
K 8 T	1	523,00
K 10 M	1	625,00
K 10 T	1	622,00
K 15 M	1,5	756,00
K 15 T	1,5	745,00
K 17 M	1,5	815,00
K 17 T	1,5	810,00
K 20 M	2,5	841,00
K 20 T	2,5	760,00
K 25 M	2,5	973,00
K 25 T	2,5	899,00
K 30 T	3	1.441,00
K 31 T	3	1.192,00
K 40 T	4	1.621,00
K 41 T	4	1.233,00
K 55 T	5,5	1.689,00
K 56 T	5,5	1.444,00
K 75 T	7,5	3.409,00
K 100 T	10	3.514,00
K 125 T	12,5	4.313,00
K 150 T	15	4.419,00

CB

CB 100 M	1	519,00
CB 100 T	1	519,00
CB 160 M	1,5	713,00
CB 160 T	1,5	692,00
CB 210 M	2,2	787,00
CB 210 T	2,2	754,00
CB 310 T	3	767,00
CB 400 T	4	1.516,00
CB 600 T	5,5	1.567,00
CB 750 T	7,5	1.895,00

**KI- AISI 304**

KI 12 M INOX	1	561,00
KI 16 M INOX	1,3	697,00
KI 16 T INOX	1,3	656,00
KI 22 M INOX	2	852,00

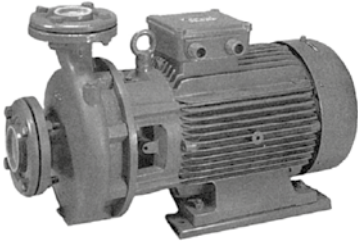
	TIPO TYPE	CV HP	PVP € Motor IE-3
	HK		
	HK 10 M	1	530,00
	HK 10 T	1	529,00
	HK 25 M	2,5	983,00
	HK 25 T	2,5	905,00
	HK 40 T	4	1.354,00
	HK 55 T	5,5	1.511,00
	HK 75 T	7,5	3.310,00
	HK 100 T	10	3.452,00
	HK 101 T	10	3.514,00
	HK 102 T	10	4.180,00
	HK 125 T	12,5	4.291,00
	HK 126 T	12,5	4.418,00
	HK 150 T	15	4.451,00
HK 151 T	15	4.582,00	

	TIPO TYPE	CV HP	PVP € HIERRO	PVP € BRONCE
--	--------------	----------	-----------------	-----------------

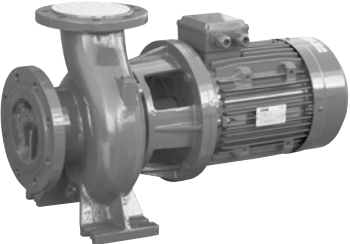
	CR			
	CR 300	3	1.508,00	CONSULTAR
	CR 400	4	1.721,00	CONSULTAR
	CR 550	5,5	2.197,00	CONSULTAR
	CR 551	5,5	2.203,00	CONSULTAR
	CR 750	7,5	2.585,00	CONSULTAR
	CR 1000	10	3.016,00	CONSULTAR
	CR 1250	12,5	3.399,00	CONSULTAR
	CR 1500	15	3.609,00	CONSULTAR

* Estas bombas no equipan contrabridas de serie.

* Counterflanges are not equipped as standard.

	TIPO TYPE	CV HP	PVP € Monof / Single-Ph	PVP € Trif / Three-Ph
--	--------------	----------	----------------------------	--------------------------

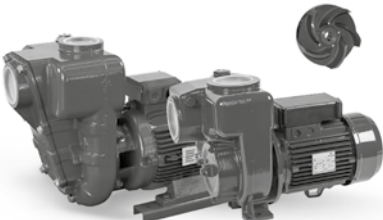
	AG			
	AG 50-1,1	1,5	710,00	793,00
	AG 50-1,5	2	752,00	808,00
	AG 80-2,2	3	-	995,00
	AG 80-4	5,5	-	1.919,00
	AG 80-5,5	7,5	-	2.315,00

	TIPO TYPE	CV HP	PVP € Motor IE3
--	--------------	----------	--------------------

MN

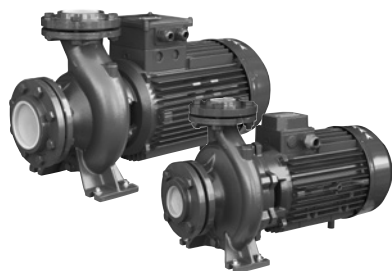

MN 32-160 C Monofásica	2		1.209,00
MN 32-160 C	2		1.198,00
MN 32-160 B	3		1.227,00
MN 32-160 A	4		1.270,00
MN 32-200 C	5,5		1.599,00
MN 32-200 B	7,5		2.119,00
MN 32-200 A	10		2.231,00
MN 32-250 C	12,5		3.003,00
MN 32-250 B	15		3.156,00
MN 32-250 A	20		4.360,00
MN 40-125 C Monofásica	2		1.259,00
MN 40-125 C	2		1.242,00
MN 40-125 B	3		1.272,00
MN 40-125 A	4		1.316,00
MN 40-160 B	4		1.503,00
MN 40-160 A	5,5		1.554,00
MN 40-200 B	7,5		2.125,00
MN 40-200 A	10		2.241,00
MN 40-250 B	15		3.029,00
MN 40-250 A	20		4.321,00
MN 50-125 B	4		1.502,00
MN 50-125 A	5,5		1.552,00
MN 50-160 B	7,5		2.113,00
MN 50-160 A	10		2.226,00
MN 50-200 C	12,5		2.869,00
MN 50-200 B	15		3.017,00
MN 50-200 A	20		4.251,00
MN 50-250 C	20		4.378,00
MN 50-250 B	25		4.905,00
MN 50-250 A	30		5.573,00
MN 65-125 B	7,5		2.176,00
MN 65-125 A	10		2.290,00
MN 65-160 C	12,5		2.879,00
MN 65-160 B	15		3.029,00
MN 65-160 A	20		4.251,00
MN 65-200 C	20		4.378,00
MN 65-200 B	25		4.899,00
MN 65-200 A	30		5.183,00
MN 80-160 D	15		3.187,00
MN 80-160 C	20		4.384,00
MN 80-160 B	25		4.909,00
MN 80-160 A	30		5.188,00

PARA VOLTAJES ESPECIALES,
LOS PRECIOS INDICADOS SE
INCREMENTARAN UN 4%

FOR SPECIAL VOLTAGES, THE
PRICES WILL BE INCREASED 4%

Voltaje habitual para Potencias hasta 5,5 HP 230-400V a partir de 7,5 HP 400/690V
Standard Voltage up to 5,5 HP- 230/400V from 7,5 HP 400/690V

	TIPO TYPE	CV HP	PVP € Motor IE-3
--	--------------	----------	---------------------

NKM-G- 1.450 RPM CON ACOPLAMIENTO

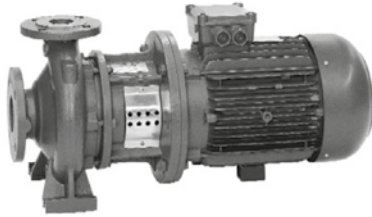

1.450 R.P.M.

NKM-G 32-125.1/140	0,33	1.338,00
NKM-G 32-125 /142	0,5	1.343,00
NKM-G 32-160.1/169	0,5	1.679,00
NKM-G 32-160/169	0,75	1.718,00
NKM-G 32-200.1/200	0,75	1.852,00
NKM-G 32-200/200	1	1.868,00
NKM-G 32-200/219	1,5	1.951,00
NKM-G 40-125/115	0,33	1.529,00
NKM-G 40-125/130	0,5	1.534,00
NKM-G 40-125/142	0,75	1.568,00
NKM-G 40-160/153	0,75	1.928,00
NKM-G 40-160/166	1	1.944,00
NKM-G 40-200/200	1,5	2.102,00
NKM-G 40-200/219	2	2.153,00
NKM-G 40-250/245	3	2.668,00
NKM-G 40-250/260	4	2.718,00
NKM-G 50-125/130	0,75	1.928,00
NKM-G 50-125/141	1	1.944,00
NKM-G 50-160/161	1,5	2.062,00
NKM-G 50-160/177	2	2.112,00
NKM-G 50-200/210	3	2.411,00
NKM-G 50-200/219	4	2.460,00
NKM-G 50-250/263	5,5	2.994,00
NKM-G 65-125/130	1	2.034,00
NKM-G 65-125/144	1,5	2.117,00
NKM-G 65-160/153	1,5	2.172,00
NKM-G 65-160/165	2	2.223,00
NKM-G 65-160/177	3	2.330,00
NKM-G 65-200/210	4	2.807,00
NKM-G 65-200/219	5,5	2.989,00
NKM-G 65-250/263	7,5	3.994,00
NKM-G 65-315/279	10	4.834,00
NKM-G 65-315/309	15	5.359,00
NKM-G 80-160/153	2	2.499,00
NKM-G 80-160/163	3	2.606,00
NKM-G 80-160/177	4	2.656,00
NKM-G 80-200/200	5,5	3.403,00
NKM-G 80-200/222	7,5	3.729,00
NKM-G 80-250/240	10	4.975,00
NKM-G 80-250/270	15	5.501,00
NKM-G 80-315/305	20	5.943,00
NKM-G 80-315/320	25	6.541,00
NKM-G 80-315/334	30	6.717,00
NKM-G 100-200/200	7,5	4.173,00
NKM-G 100-200/214	10	4.468,00
NKM-G 100-250/250	15	5.719,00
NKM-G 100-250/270	20	6.022,00
NKM-G 100-315/300	25	6.890,00
NKM-G 100-315/316	30	7.067,00
NKM-G 125-250/243	20	6.217,00
NKM-G 125-250/256	25	6.814,00
NKM-G 125-250/266	30	6.991,00
NKM-G 150-200/218	15	7.186,00

PARA OTRAS EFICIENCIAS DE
MOTOR CONSULTE CON NUESTRO
DEPARTAMENTO COMERCIAL

FOR OTHER MOTOR EFFICIENCIES,
CONTACT WITH OUR COMMERCIAL
DEPARTMENT

Voltaje habitual para Potencias hasta 5,5 HP 230-400V a partir de 7,5 HP 400/690V
Standard Voltage up to 5,5 HP- 230/400V from 7,5 HP 400/690V

	TIPO TYPE	CV HP	PVP € Motor IE-3
--	--------------	----------	---------------------

NKP-G 2,900 R.P.M. CON ACOPLAMIENTO

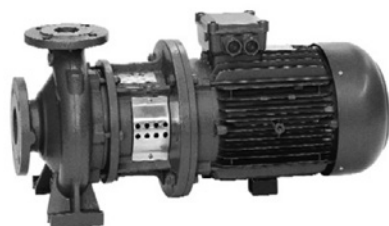

2.900 R.P.M.

NKP-G 32-125.1/102	1	1.378,00
NKP-G 32-125.1/115	1,5	1.401,00
NKP-G 32-125.1/125	2	1.452,00
NKP-G 32-125.1/140	3	1.484,00
NKP-G 32-125/110	1,5	1.401,00
NKP-G 32-125/120	2	1.452,00
NKP-G 32-125/130	3	1.603,00
NKP-G 32-125/142	4	1.864,00
NKP-G 32-160.1/155	3	1.867,00
NKP-G 32-160.1/166	4	2.053,00
NKP-G 32-160/151	4	2.053,00
NKP-G 32-160/163	5,5	2.149,00
NKP-G 32-160/177	7,5	2.650,00
NKP-G 32-200.1/188	5,5	2.534,00
NKP-G 32-200.1/205	7,5	2.802,00
NKP-G 32-200/190	7,5	2.802,00
NKP-G 32-200/210	10	2.990,00
NKP-G 40-125/107	2	1.644,00
NKP-G 40-125/120	3	1.676,00
NKP-G 40-125/130	4	1.937,00
NKP-G 40-125/139	5,5	2.034,00
NKP-G 40-160/158	7,5	2.790,00
NKP-G 40-160/172	10	2.979,00
NKP-G 40-200/210	15	3.757,00
NKP-G 40-250/230	20	4.049,00
NKP-G 40-250/245	25	4.243,00
NKP-G 40-250/260	30	4.925,00
NKP-G 50-125/115	4	2.437,00
NKP-G 50-125/125	5,5	2.534,00
NKP-G 50-125/135	7,5	2.937,00
NKP-G 50-125/144	10	3.107,00
NKP-G 50-160/153	10	3.092,00
NKP-G 50-160/169	15	3.757,00
NKP-G 50-200/200	20	4.014,00
NKP-G 50-200/210	25	4.208,00
NKP-G 50-200/219	30	4.890,00
NKP-G 50-250/230	30	5.005,00
NKP-G 50-250/257	40	5.658,00
NKP-G 65-125/120/110	5,5	2.642,00
NKP-G 65-125/127	7,5	2.974,00
NKP-G 65-125/137	10	3.162,00
NKP-G 65-160/157	15	3.857,00
NKP-G 65-160/173	20	4.009,00
NKP-G 65-200/190	25	4.348,00
NKP-G 65-200/200	30	5.030,00
NKP-G 65-200/219	40	5.654,00
NKP-G 80-160/147/127	15	4.033,00
NKP-G 80-160/153	20	4.184,00
NKP-G 80-160/163	25	4.377,00
NKP-G 80-160/169	30	5.060,00
NKP-G 80-200/190	40	6.179,00

PARA OTRAS EFICIENCIAS DE
MOTOR CONSULTE CON NUESTRO
DEPARTAMENTO COMERCIAL

FOR OTHER MOTOR EFFICIENCIES,
CONTACT WITH OUR COMMERCIAL
DEPARTMENT

Voltaje habitual para Potencias hasta 5,5 HP 230-400V a partir de 7,5 HP 400/690V
Standard Voltage up to 5,5 HP- 230/400V from 7,5 HP 400/690V

TIPO TYPE	PVP € BOMBA/Pump
--------------	---------------------

KDN- EJE LIBRE

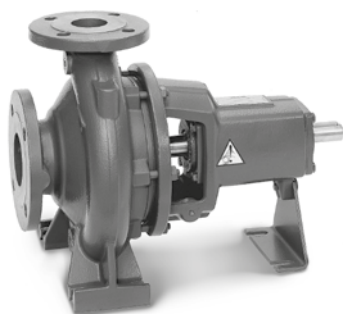

KDN 32-125.1	1.751,00
KDN 32-125	1.765,00
KDN 32-160.1	1.837,00
KDN 32-160	1.852,00
KDN 32-200.1	1.955,00
KDN 32-200	1.967,00
KDN 40-125	1.872,00
KDN 40-160	1.956,00
KDN 40-200	2.039,00
KDN 40-250	2.207,00
KDN 50-125	1.966,00
KDN 50-160	2.023,00
KDN 50-200	2.089,00
KDN 50-250	2.264,00
KDN 65-125	2.043,00
KDN 65-160	2.075,00
KDN 65-200	2.231,00
KDN 65-250	2.876,00
KDN 65-315	3.450,00
KDN 80-160	2.267,00
KDN 80-200	2.648,00
KDN 80-250	3.247,00
KDN 80-315	3.704,00
KDN 100-200	3.077,00
KDN 100-250	3.464,00
KDN 100-315	4.033,00
KDN 125-250	3.955,00
KDN 150-200	5.165,00

TIPO TYPE	CV HP	PVP € Motor IE-3
--------------	----------	---------------------

KDN- COMPLETA CON MOTOR SOBRE BANCADA A 2.900 R.P.M.

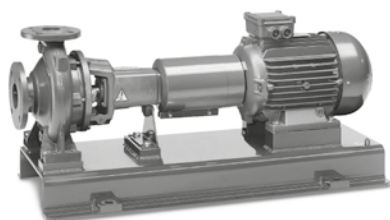

2.900 R.P.M.

KDN 32-125 1	1	2.843,00
2.900 R.P.M.	1,5	2.866,00
	2	2.915,00
	3	2.947,00
	4	3.215,00
	5,5	3.333,00
KDN 32-125	1,5	2.881,00
2.900 R.P.M.	2	2.930,00
	3	2.962,00
	4	3.230,00
	5,5	3.349,00
KDN 32-160 1	1,5	2.957,00
2.900 R.P.M.	2	3.006,00
	3	3.038,00
	4	3.306,00
	5,5	3.424,00
	7,5	3.706,00
KDN 32-160	3	3.053,00
2.900 R.P.M.	4	3.321,00
	5,5	3.439,00
	7,5	3.721,00
	10	3.888,00

	TIPO TYPE	CV HP	PVP € Motor IE-3
--	--------------	----------	---------------------

**KDN- COMPLETA CON MOTOR SOBRE BANCADA
A 2,900 R.P.M.**

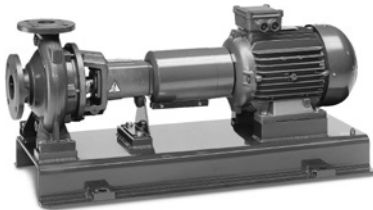

2.900 R.P.M.

KDN 32-200 1 2.900 R.P.M.	3	3.162,00	
	4	3.430,00	
	5,5	3.548,00	
	7,5	3.830,00	
	10	3.997,00	
	KDN 32-200 2.900 R.P.M.	4	3.442,00
		5,5	3.560,00
		7,5	3.842,00
		10	4.009,00
		15	4.768,00
KDN 40-125 2.900 R.P.M.	20	4.940,00	
	2	3.043,00	
	3	3.075,00	
	4	3.343,00	
	5,5	3.461,00	
KDN 40-160 2.900 R.P.M.	7,5	3.743,00	
	10	3.910,00	
	4	3.431,00	
	5,5	3.549,00	
	7,5	3.831,00	
KDN 40-200 2.900 R.P.M.	10	3.999,00	
	15	4.757,00	
	20	4.929,00	
	5,5	3.637,00	
	7,5	3.919,00	
KDN 40-250 2.900 R.P.M.	10	4.086,00	
	15	4.844,00	
	20	5.017,00	
	25	5.502,00	
	15	5.021,00	
KDN 50-125 2.900 R.P.M.	20	5.194,00	
	25	5.679,00	
	30	6.621,00	
	40	7.229,00	
	4	3.441,00	
KDN 50-160 2.900 R.P.M.	5,5	3.559,00	
	7,5	3.841,00	
	10	4.008,00	
	15	4.767,00	
	5,5	3.619,00	
KDN 50-200 2.900 R.P.M.	7,5	3.901,00	
	10	4.068,00	
	15	4.827,00	
	20	4.999,00	
	25	5.485,00	
KDN 50-250 2.900 R.P.M.	10	4.138,00	
	15	4.897,00	
	20	5.069,00	
	25	5.555,00	
	30	6.497,00	
KDN 50-250 2.900 R.P.M.	40	7.104,00	
	20	5.254,00	
	25	5.739,00	
	30	6.681,00	
	40	7.289,00	
	50	7.460,00	
	60	8.048,00	

PARA OTRAS EFICIENCIAS DE
MOTOR CONSULTE CON NUESTRO
DEPARTAMENTO COMERCIAL

FOR OTHER MOTOR EFFICIENCIES,
CONTACT WITH OUR COMMERCIAL
DEPARTMENT

	TIPO TYPE	CV HP	PVP € Motor IE-3
--	--------------	----------	---------------------

KDN- COMPLETA CON MOTOR SOBRE BANCADA A 2,900 R.P.M.

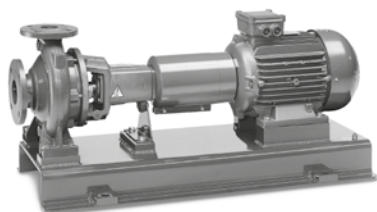

2.900 R.P.M.

KDN 65-125 2.900 R.P.M.	5,5	3.641,00
	7,5	3.923,00
	10	4.090,00
	15	4.849,00
	20	5.021,00
KDN 65-160 2.900 R.P.M.	7,5	3.956,00
	10	4.123,00
	15	4.881,00
	20	5.054,00
	25	5.539,00
	30	6.481,00
KDN 65-200 2.900 R.P.M.	15	5.046,00
	20	5.219,00
	25	5.704,00
	30	6.646,00
	40	7.254,00
	50	7.425,00
KDN 65-250 2.900 R.P.M.	30	7.325,00
	40	7.933,00
	50	8.104,00
	60	8.692,00
	75	10.462,00
KDN 65-315 2.900 R.P.M.	40	8.537,00
	50	8.708,00
	60	9.296,00
	75	11.066,00
	100	14.076,00
	125	14.646,00
KDN 80-160 2.900 R.P.M.	150	20.178,00
	10	4.325,00
	15	5.083,00
	20	5.256,00
	25	5.741,00
	30	6.683,00
	40	7.291,00
KDN 80-200 2.900 R.P.M.	50	7.462,00
	25	6.143,00
	30	7.085,00
	40	7.693,00
	50	7.864,00
	60	8.452,00
KDN 80-250 2.900 R.P.M.	75	10.222,00
	100	12.253,00
	50	8.494,00
	60	9.082,00
	75	10.852,00
KDN 80-315 2.900 R.P.M.	100	12.883,00
	125	13.453,00
	75	11.066,00
	100	14.076,00
	125	14.646,00
	150	20.178,00

	TIPO TYPE	CV HP	PVP € Motor IE-3
--	--------------	----------	---------------------

**KDN- COMPLETA CON MOTOR SOBRE BANCADA
A 2,900 R.P.M.**



2.900 R.P.M.

KDN 100-200 2.900 R.P.M.	40	8.144,00
	50	8.315,00
	60	8.903,00
	75	10.673,00
	100	12.704,00
KDN 100-250 2.900 R.P.M.	125	13.274,00
	60	9.310,00
	75	11.080,00
	100	13.111,00
	125	13.682,00
	150	19.213,00

**KDN- COMPLETA CON MOTOR SOBRE BANCADA
A 1,450 R.P.M.**

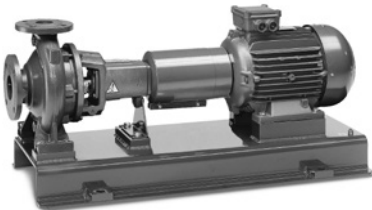

1.450 R.P.M.

KDN 32-125 1 1.450 R.P.M.	0,5	2.803,00
	0,75	2.906,00
	1	2.907,00
KDN 32-125 1.450 R.P.M.	0,5	2.819,00
	0,75	2.922,00
	1	2.907,00
KDN 32-160 1 1.450 R.P.M.	0,5	2.894,00
	0,75	2.997,00
	1	2.982,00
KDN 32-160 1.450 R.P.M.	0,5	2.909,00
	0,75	3.012,00
	1	2.997,00
KDN 32-200 1 1.450 R.P.M.	1,5	3.078,00
	0,5	3.018,00
	0,75	3.121,00
KDN 32-200 1.450 R.P.M.	1	3.106,00
	1,5	3.187,00
	0,5	3.030,00
KDN 40-125 1.450 R.P.M.	0,75	3.133,00
	1	3.118,00
	1,5	3.199,00
KDN 40-160 1.450 R.P.M.	2	3.249,00
	3	3.344,00
	0,5	2.931,00
KDN 40-200 1.450 R.P.M.	0,75	3.034,00
	1	3.019,00
	1,5	3.100,00
KDN 40-200 1.450 R.P.M.	0,5	3.020,00
	0,75	3.122,00
	1	3.107,00
KDN 40-200 1.450 R.P.M.	1,5	3.189,00
	2	3.238,00
	0,75	3.210,00
KDN 40-200 1.450 R.P.M.	1	3.195,00
	1,5	3.276,00
	2	3.325,00
KDN 40-200 1.450 R.P.M.	3	3.421,00
	4	3.493,00

PARA OTRAS EFICIENCIAS DE
MOTOR CONSULTE CON NUESTRO
DEPARTAMENTO COMERCIAL

FOR OTHER MOTOR EFFICIENCIES,
CONTACT WITH OUR COMMERCIAL
DEPARTMENT

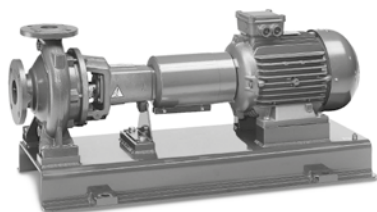
TIPO
TYPE
CV
HP
PVP €
Motor IE-3
**KDN- COMPLETA CON MOTOR SOBRE BANCADA
 A 1,450 R.P.M.**

1.450 R.P.M.

KDN 40-250 1.450 R.P.M.	2	3.502,00
	3	3.597,00
	4	3.766,00
	5,5	3.944,00
	0,5	3.029,00
KDN 50-125 1.450 R.P.M.	0,75	3.132,00
	1	3.117,00
	1,5	3.198,00
	2	3.248,00
	1	3.177,00
KDN 50-160 1.450 R.P.M.	1,5	3.258,00
	2	3.308,00
	3	3.403,00
	4	3.571,00
	1	3.247,00
KDN 50-200 1.450 R.P.M.	1,5	3.328,00
	2	3.378,00
	3	3.473,00
	4	3.545,00
	5,5	3.820,00
KDN 50-250 1.450 R.P.M.	3	3.658,00
	4	3.826,00
	5,5	4.004,00
	7,5	4.269,00
KDN 65-125 1.450 R.P.M.	1	3.199,00
	1,5	3.280,00
	2	3.330,00
	3	3.425,00
KDN 65-160 1.450 R.P.M.	1	3.232,00
	1,5	3.313,00
	2	3.362,00
	3	3.458,00
KDN 65-200 1.450 R.P.M.	4	3.626,00
	1,5	3.478,00
	2	3.527,00
	3	3.623,00
KDN 65-250 1.450 R.P.M.	4	3.791,00
	5,5	3.969,00
	7,5	4.234,00
	4	4.470,00
	5,5	4.648,00
KDN 65-315 1.450 R.P.M.	7,5	4.913,00
	10	5.203,00
	15	5.797,00
	7,5	5.606,00
	10	5.895,00
	15	6.400,00
	20	6.718,00
	25	7.696,00

	TIPO TYPE	CV HP	PVP € Motor IE-3
--	--------------	----------	---------------------

**KDN- COMPLETA CON MOTOR SOBRE BANCADA
A 1,450 R.P.M.**

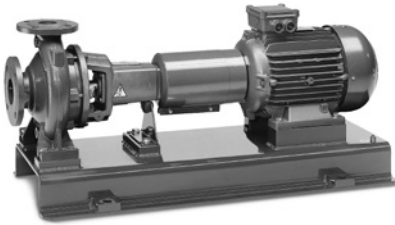

1.450 R.P.M.

KDN 80-160 1.450 R.P.M.	1,5	3.515,00	
	2	3.564,00	
	3	3.660,00	
	4	3.828,00	
	5,5	4.006,00	
	7,5	4.271,00	
	KDN 80-200 1.450 R.P.M.	2	3.966,00
		3	4.062,00
		4	4.230,00
		5,5	4.408,00
7,5		4.673,00	
KDN 80-250 1.450 R.P.M.	10	4.962,00	
	15	5.556,00	
	5,5	5.038,00	
	7,5	5.303,00	
	10	5.592,00	
KDN 80-315 1.450 R.P.M.	15	6.186,00	
	20	6.504,00	
	10	6.074,00	
	15	6.668,00	
KDN 100-200 1.450 R.P.M.	20	6.986,00	
	25	7.964,00	
	30	8.228,00	
	40	9.335,00	
	4	4.681,00	
KDN 100-250 1.450 R.P.M.	5,5	4.859,00	
	7,5	5.124,00	
	10	5.413,00	
	15	6.007,00	
	20	6.325,00	
KDN 100-315 1.450 R.P.M.	7,5	5.531,00	
	10	5.821,00	
	15	6.415,00	
	20	6.732,00	
KDN 125-250 1.450 R.P.M.	25	7.710,00	
	15	7.014,00	
	20	7.332,00	
	25	8.310,00	
	30	8.574,00	
KDN 150-200 1.450 R.P.M.	40	9.681,00	
	50	10.174,00	
	10	6.338,00	
	15	6.932,00	
	20	7.346,00	
KDN 150-250 1.450 R.P.M.	25	8.324,00	
	30	8.492,00	
	40	9.599,00	
	7,5	7.411,00	
	10	7.700,00	
	15	8.205,00	
	20	8.715,00	

PARA OTRAS EFICIENCIAS DE
MOTOR CONSULTE CON NUESTRO
DEPARTAMENTO COMERCIAL

FOR OTHER MOTOR EFFICIENCIES,
CONTACT WITH OUR COMMERCIAL
DEPARTMENT

	TIPO TYPE	CV HP	PVP € Bomba Suelta Only Pump	Bomba/Pump + Motor FRS (Saci) PVP €	
				Motor SACI	Motor Trif. 400V

AR- SUMERGIBLES 4" TURBINA FLOTANTE



AR 15-19	0,75	201,00	536,00	536,00
AR 15-26	1	277,00	632,00	632,00
AR 15-38	1,5	396,00	795,00	772,00
AR 20-15	0,75	183,00	518,00	518,00
AR 20-20	1	221,00	576,00	576,00
AR 20-30	1,5	322,00	721,00	698,00
AR 20-36	2	366,00	814,00	773,00
AR 30-10	0,75	148,00	483,00	483,00
AR 30-14	1	176,00	531,00	531,00
AR 30-20	1,5	217,00	616,00	593,00
AR 40-11	1	153,00	508,00	508,00
AR 40-16	1,5	190,00	589,00	566,00
AR 40-21	2	222,00	670,00	629,00
AR 40-32	3	301,00	828,00	781,00
AR 60-07	0,75	135,00	470,00	470,00
AR 60-09	1	148,00	503,00	503,00
AR 60-14	1,5	190,00	589,00	566,00
AR 60-18	2	222,00	670,00	629,00
AR 60-27	3	291,00	818,00	771,00
AR 60-35	4	388,00	-	1.000,00
AR 60-48	5,5	489,00	-	1.324,00
AR 110-07	1	153,00	508,00	508,00
AR 110-10	1,5	185,00	584,00	561,00
AR 110-14	2	222,00	670,00	629,00
AR 110-20	3	287,00	814,00	767,00
AR 110-27	4	360,00	-	972,00
AR 110-36	5,5	476,00	-	1.311,00
AR 140-06	1,5	148,00	547,00	524,00
AR 140-08	2	167,00	615,00	574,00
AR 140-13	3	227,00	754,00	707,00
AR 140-17	4	263,00	-	875,00
AR 140-23	5,5	333,00	-	1.168,00
AR 140-32	7,5	429,00	-	1.390,00
AR 200-07	2	213,00	661,00	620,00
AR 200-10	3	268,00	795,00	748,00
AR 200-14	4	341,00	-	953,00
AR 200-19	5,5	457,00	-	1.292,00
AR 200-26	7,5	618,00	-	1.579,00
AR 250-08	3	272,00	799,00	752,00
AR 250-11	4	351,00	-	963,00
AR 250-15	5,5	452,00	-	1.287,00
AR 250-20	7,5	577,00	-	1.538,00

*** LAS BOMBAS MONOFASICAS INCLUYEN CONDENSADOR DE ARRANQUE

*** LAS BOMBAS CON MOTOR SE ENTREGARAN DESMONTADAS (BOMBA Y MOTOR SUELTO) PARA EVITAR ROTURAS EN TRANSPORTE.

*** LAS BOMBAS TRIFASICAS MUESTRAN PRECIOS CON MOTORES TRIFASICOS A 400 V

	TIPO TYPE	CV HP	PVP € Bomba Suelta Only Pump	Bomba/Pump + Motor FRS (Saci) PVP €	
				Motor SACI	Motor Trif. 400V

SP- SUMERGIBLES 4" AISI-304



SP 10-13	0,75	340,00	675,00	675,00
SP 10-18	1	430,00	785,00	785,00
SP 10-23	1,5	522,00	921,00	898,00
SP 10-33	2	759,00	1.207,00	1.166,00
SP 10-48	3	1.150,00	1.677,00	1.630,00
SP 18-09	0,75	271,00	606,00	606,00
SP 18-12	1	326,00	681,00	681,00
SP 18-18	1,5	430,00	829,00	806,00
SP 18-25	2	559,00	1.007,00	966,00
SP 18-33	3	759,00	1.286,00	1.239,00
SP 18-45	4	1.091,00	-	1.703,00
SP 25-06	0,75	228,00	563,00	563,00
SP 25-08	1	264,00	619,00	619,00
SP 25-12	1,5	332,00	731,00	708,00
SP 25-17	2	425,00	873,00	832,00
SP 25-21	3	497,00	1.024,00	977,00
SP 25-25	3	573,00	1.100,00	1.053,00
SP 25-33	4	759,00	-	1.371,00
SP 25-44	5,5	1.072,00	-	1.907,00
SP 40-07	1,5	511,00	910,00	887,00
SP 40-10	2	663,00	1.111,00	1.070,00
SP 40-15	3	907,00	1.434,00	1.387,00
SP 40-18	4	1.052,00	-	1.664,00
SP 40-25	5,5	1.396,00	-	2.231,00
SP 70-07	3	694,00	1.221,00	1.174,00
SP 70-10	4	913,00	-	1.525,00
SP 70-13	5,5	1.131,00	-	1.966,00
SP 70-18	7,5	1.313,00	-	2.274,00
SP 70-25	10	1.823,00	-	3.023,00

*** LAS BOMBAS MONOFASICAS INCLUYEN CONDENSADOR DE ARRANQUE

*** LAS BOMBAS CON MOTOR SE ENTREGARAN DESMONTADAS (BOMBA Y MOTOR SUELTO) PARA EVITAR ROTURAS EN TRANSPORTE.

*** LAS BOMBAS TRIFASICAS MUESTRAN PRECIOS CON MOTORES TRIFASICOS A 400 V



	TIPO TYPE	CV HP	PVP € Bomba Suelta Only Pump	Bomba/Pump + Motor SACI PVP €
--	--------------	----------	------------------------------------	----------------------------------

AS- SUMERGIBLES 6" RADIALES



AS6 75-6	5,5 - 4"	800,00	1.635,00
AS6 75-09	7,5 - 4"	899,00	1.860,00
AS6 75-12	10	1.070,00	3.467,00
AS6 75-15	12,5	1.170,00	3.780,00
AS6 75-18	15	1.271,00	3.980,00
AS6 75-24	20	1.472,00	4.937,00
AS6 135-4	5,5 - 4"	759,00	1.594,00
AS6 135-6	7,5 - 4"	841,00	1.802,00
AS6 135-8	10	991,00	3.388,00
AS6 135-10	12,5	1.071,00	3.681,00
AS6 135-12	15	1.153,00	3.862,00
AS6 135-16	20	1.313,00	4.778,00
AS6 135-20	25	1.517,00	5.124,00
AS6 135-24	30	1.681,00	6.021,00
AS6 180-3	5,5 - 4"	773,00	1.608,00
AS6 180-4	7,5 - 4"	819,00	1.780,00
AS6 180-5	10	937,00	3.334,00
AS6 180-6	12,5	980,00	3.590,00
AS6 180-8	15	1.142,00	3.851,00
AS6 180-10	20	1.311,00	4.776,00
AS6 180-13	25	1.466,00	5.073,00
AS6 180-15	30	1.565,00	5.905,00
AS6 220-3	7,5 - 4"	771,00	1.732,00
AS6 220-4	10	952,00	3.349,00
AS6 220-5	12,5	997,00	3.607,00
AS6 220-6	15	1.043,00	3.752,00
AS6 220-9	20	1.184,00	4.649,00
AS6 220-11	25	1.280,00	4.887,00
AS6 220-14	30	1.418,00	5.758,00

*TODOS LOS MOTORES DE 5,5 Y 7,5 CV SON DE 4" Y PARA POTENCIAS DE 10 A 30 CV EQUIPAN MOTOR CON ARRANQUE ESTRELLA TRIANGULO.
 * FOR POWERS OF UP TO 7,5 HP, THE MOTOR IS 4". FROM 10 HP, THE MOTORS ARE 6".

	TIPO TYPE	CV HP	PVP €
--	--------------	----------	-------



CAMISAS DE REFRIGERACIÓN

CAMISAS DE REFRIGERACIÓN 4" (DIAMETRO 105)
 CAMISAS DE REFRIGERACIÓN 6" (DIAMETRO 200)

442,00
 774,00

	TIPO TYPE	CV HP	PVP € Bomba Suelta Only Pump	Bomba/Pump + Motor SACI PVP €
--	--------------	----------	------------------------------------	----------------------------------

SX- SUMERGIBLES SEMIAXIALES 6"-8"-10"



SX 617-06	5,5 - 6"	1.048,00	3.119,00
SX 617-08	7,5	1.260,00	3.438,00
SX 617-10	7,5	1.472,00	3.650,00
SX 617-11	10	1.559,00	3.956,00
SX 617-13	10	1.766,00	4.163,00
SX 617-15	12,5	1.972,00	4.582,00
SX 617-17	15	2.184,00	4.893,00
SX 617-18	15	2.295,00	5.004,00
SX 617-20	15	2.514,00	5.223,00
SX 617-24	20	2.943,00	6.408,00
SX 617-27	20	3.265,00	6.730,00
SX 617-29	25	3.484,00	7.091,00
SX 617-33	25	3.915,00	7.522,00
SX 617-36	30	4.240,00	8.580,00
SX 617-40	30	7.663,00	12.003,00
SX 617-48	35	8.577,00	13.166,00
SX 617-53	40	9.364,00	14.290,00
SX 617-55	50	9.808,00	15.025,00

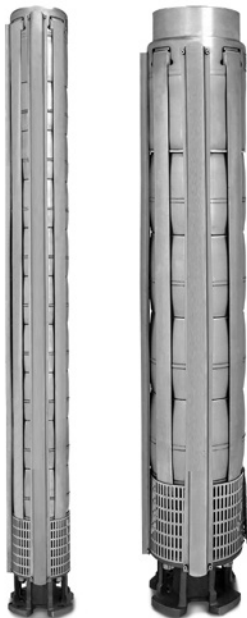

SX 630-04	5,5 - 6"	921,00	2.992,00
SX 630-06	7,5	1.192,00	3.370,00
SX 630-08	10	1.494,00	3.891,00
SX 630-11	12,5	1.899,00	4.509,00
SX 630-13	15	2.160,00	4.869,00
SX 630-15	17,5	2.419,00	5.446,00
SX 630-17	20	2.728,00	6.193,00
SX 630-19	25	2.991,00	6.598,00
SX 630-21	25	3.310,00	6.917,00
SX 630-23	30	3.621,00	7.961,00
SX 630-26	30	3.972,00	8.312,00
SX 630-28	35	4.259,00	8.848,00
SX 630-30	35	4.592,00	9.181,00
SX 630-32	40	4.848,00	9.774,00
SX 630-35	40	5.319,00	10.245,00
SX 630-39	50	10.241,00	15.458,00
SX 630-43	50	11.015,00	16.232,00

	TIPO TYPE	CV HP	PVP € Bomba Suelta Only Pump	Bomba/Pump + Motor SACI PVP €
--	--------------	----------	------------------------------------	----------------------------------

SX- SUMERGIBLES SEMIAXIALES 6"-8"-10"



SX 646-03	7,5	939,00	3.117,00
SX 646-05	10	1.277,00	3.674,00
SX 646-06	12,5	1.497,00	4.107,00
SX 646-07	15	1.665,00	4.374,00
SX 646-08	17,5	1.833,00	4.860,00
SX 646-09	20	2.002,00	5.467,00
SX 646-10	20	2.205,00	5.670,00
SX 646-11	25	2.409,00	6.016,00
SX 646-12	25	2.586,00	6.193,00
SX 646-14	30	2.982,00	7.322,00
SX 646-15	30	3.152,00	7.492,00
SX 646-16	35	3.351,00	7.940,00
SX 646-17	35	3.605,00	8.194,00
SX 646-18	40	3.727,00	8.653,00
SX 646-20	40	4.029,00	8.955,00
SX 646-22	50	4.526,00	9.743,00
SX 646-24	50	4.781,00	9.998,00

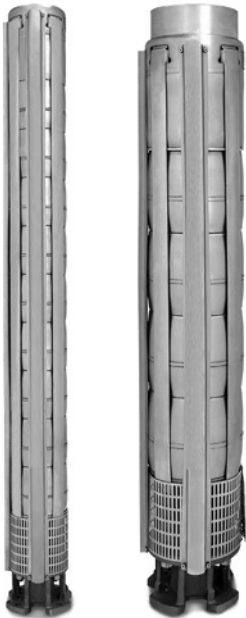

SX 660-02	5,5-6"	842,00	2.913,00
SX 660-03	7,5	994,00	3.172,00
SX 660-04	10	1.143,00	3.540,00
SX 660-05	12,5	1.370,00	3.980,00
SX 660-06	15	1.506,00	4.215,00
SX 660-07	17,5	1.691,00	4.718,00
SX 660-08	20	1.857,00	5.322,00
SX 660-09	25	2.069,00	5.676,00
SX 660-10	25	2.283,00	5.890,00
SX 660-11	30	2.486,00	6.826,00
SX 660-12	30	2.690,00	7.030,00
SX 660-13	35	2.871,00	7.460,00
SX 660-15	40	3.222,00	8.148,00
SX 660-17	40	3.584,00	8.510,00
SX 660-18	50	3.795,00	9.012,00
SX 660-19	50	4.027,00	9.244,00
SX 660-20	50	4.255,00	9.472,00
SX 660-21	50	4.466,00	9.683,00

	TIPO TYPE	CV HP	PVP € Bomba Suelta Only Pump	Bomba/Pump + Motor SACI PVP €
SX- SUMERGIBLES SEMIAXIALES 6"-8"-10"				
	SX 896-01	6"-7,5	1.675,00	3.853,00
	SX 896-02	6"-15	1.986,00	4.695,00
	SX 896-03	6"-20	2.298,00	5.763,00
	SX 896-04	6"-30	2.610,00	6.950,00
	SX 896-05	8"-40-R	2.865,00	8.999,00
	SX 896-06	8"-50-R	3.120,00	9.749,00
	SX 896-07	8"-50-R	3.405,00	10.034,00
	SX 896-08	8"-60-R	3.741,00	10.503,00
	SX 896-09	8"-60-R	4.029,00	10.791,00
	SX 896-10	8"-75-R	4.395,00	11.969,00
	SX 896-11	8"-80-R	4.649,00	12.563,00
	SX 896-12	8"-90-R	4.904,00	13.145,00
	SX 896-13	8"-100-R	5.222,00	13.899,00
	SX 896-14	8"-100-R	5.574,00	14.251,00
	SX 896-15	8"-110-R	5.860,00	15.157,00
	SX 896-17	8"-125-R	6.378,00	16.384,00
		SX 10126-01	6"-15	3.037,00
SX 10126-02		6"-30	3.439,00	7.779,00
SX 10126-03		8"-50 R	3.892,00	10.521,00
SX 10126-04		8"-60 R	4.529,00	11.291,00
SX 10126-05		8"-75 R	5.042,00	12.616,00
SX 10126-06		8"-90 R	5.502,00	13.743,00
SX 10126-07		8"-100 R	6.322,00	14.999,00
SX 10126-08		8"-125 R	6.864,00	16.870,00
SX 10126-09		10"-150 R	7.549,00	21.817,00
SX 10126-10		10"-150 R	8.163,00	22.431,00
SX 10126-11		10"-175 R	8.672,00	24.452,00
SX 10126-12		10"-175 R	9.245,00	25.025,00
SX 10126-13		10"-200 R	10.342,00	27.546,00

	TIPO TYPE	CV HP	PVP € Bomba Suelta Only Pump	Bomba/Pump + Motor SACI PVP €
--	--------------	----------	------------------------------------	----------------------------------

SX- SUMERGIBLES SEMIAJIALES 6"-8"-10"

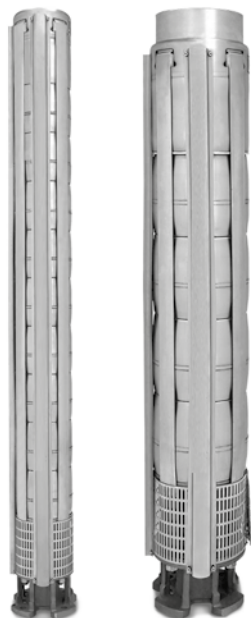

SX 10160-01	6"-17,5		3.223,00	6.250,00
SX 10160-02B	6"-25		3.647,00	7.254,00
SX 10160-02B	6"-35		3.647,00	8.236,00
SX 10160-03B	8"-40 R		4.072,00	10.206,00
SX 10160-03	8"-50 R		4.072,00	10.701,00
SX 10160-04	8"-60 R		4.799,00	11.561,00
SX 10160-05	8"-75 R		5.362,00	12.936,00
SX 10160-06B	8"-80 R		5.846,00	13.760,00
SX 10160-06	8"-90 R		5.846,00	14.087,00
SX 10160-07B	8"-100 R		6.710,00	15.387,00
SX 10160-07	8"-110 R		6.710,00	16.007,00
SX 10160-08	8"-125 R		7.409,00	17.415,00
SX 10160-09	10"-150 R		8.017,00	22.285,00
SX 10160-10	10"-150 R		8.654,00	22.922,00
SX 10160-11	10"-175 R		9.201,00	24.981,00
SX 10160-12	10"-200 R		9.823,00	27.027,00
SX 10160-13	10"-200 R		10.871,00	28.075,00
SX 10210-01B	6"-20		6.467,00	9.932,00
SX 10210-01	6"-25		6.467,00	10.074,00
SX 10210-02B2	8"-40 R		7.377,00	13.511,00
SX 10210-02	8"-50 R		7.377,00	14.006,00
SX 10210-03B3	8"-60 R		8.411,00	15.173,00
SX 10210-03	8"-75 R		8.411,00	15.985,00
SX 10210-04B2	8"-90 R		9.440,00	17.681,00
SX 10210-04	8"-100 R		9.440,00	18.117,00
SX 10210-05	8"-125 R		10.473,00	20.479,00
SX 10210-06	10"-150 R		11.565,00	25.833,00
SX 10210-07	10"-175 R		12.711,00	28.491,00
SX 10210-08	10"-200 R		17.171,00	34.375,00
SX 10210-09	10"-225 R		19.309,00	38.497,00
SX 10210-10	10"-250 R		20.010,00	39.198,00

	TIPO TYPE	CV HP	PVP € Monofasico	PVP € Trif. 400V	PVP € Trif. 230V
--	--------------	----------	---------------------	---------------------	---------------------



4"

FR- MOTORES SACI 4"

PEDROLLO 4PD 50	0,5 CV (EX FRS)	325,00	325,00	342,00
PEDROLLO 4PD 75	0,75 CV (EX FRS)	335,00	335,00	352,00
PEDROLLO 4PD 100	1 CV (EX FRS)	355,00	355,00	373,00
PEDROLLO 4PD 150	1,5 CV (EX FRS)	399,00	376,00	395,00
PEDROLLO 4PD 200	2 CV (EX FRS)	448,00	407,00	428,00
PEDROLLO 4PD 300	3 CV (EX FRS)	527,00	480,00	504,00
PEDROLLO 4PD 400	4 CV (EX FRS)	-	612,00	643,00
PEDROLLO 4PD 550	5,5 CV (EX FRS)	-	835,00	877,00
PEDROLLO 4PD 750	7,5 CV (EX FRS)	-	961,00	1.010,00
PEDROLLO 4PD 1000	10 CV (EX FRS)	-	1.200,00	1.260,00

ANODO SACRIFICIO MOTOR 4PD (EX FRS) **106,00**

LOS PRECIOS DE LOS MOTORES MONOFASICOS INCLUYEN LOS CONDENSADORES DE ARRANQUE



4"

MOTORES FRANKLIN 4"

FRANKLIN	0,75 CV	593,00	570,00
FRANKLIN	1 CV	635,00	608,00
FRANKLIN	1,5 CV	731,00	696,00
FRANKLIN	2 CV	892,00	798,00
FRANKLIN	3 CV	1.128,00	986,00
FRANKLIN	4 CV SUPER	-	1.453,00
FRANKLIN	5,5 CV	-	1.641,00
FRANKLIN	7,5 CV	-	1.905,00
FRANKLIN	10 CV	-	2.465,00

LOS PRECIOS DE LOS MOTORES MONOFASICOS INCLUYEN LOS CONDENSADORES DE ARRANQUE

TIPO
TYPE

CV
HP

PVP €
A. directo/Direct

PVP €
A. Est-Triang/Star Delta

MOTORES SACI REBOBINABLES REFRIG. POR AGUA 6"-8"-10"



6"
MOTOR
REBOBINABLE

6" MOT 5.5	2.071,00	2.071,00
6" MOT 7.5	2.178,00	2.178,00
6" MOT 10	2.397,00	2.397,00
6" MOT 12.5	2.610,00	2.610,00
6" MOT 15	2.709,00	2.709,00
6" MOT 17.5	3.027,00	3.027,00
6" MOT 20	3.465,00	3.465,00
6" MOT 25	3.607,00	3.607,00
6" MOT 30	4.340,00	4.340,00
6" MOT 35	4.589,00	4.589,00
6" MOT 40	4.926,00	4.926,00
6" MOT 50	5.217,00	5.217,00

8"
MOTOR
REBOBINABLE

8" MOT 40	6.134,00	6.134,00
8" MOT 50	6.629,00	6.629,00
8" MOT 60	6.762,00	6.762,00
8" MOT 75	7.574,00	7.574,00
8" MOT 80	7.914,00	7.914,00
8" MOT 90	8.241,00	8.241,00
8" MOT 100	8.677,00	8.677,00
8" MOT 110	9.297,00	9.297,00
8" MOT 125	10.006,00	10.006,00

10"
MOTOR
REBOBINABLE

10" MOT 125	13.109,00	13.109,00
10" MOT 150	14.268,00	14.268,00
10" MOT 175	15.780,00	15.780,00
10" MOT 200	17.204,00	17.204,00
10" MOT 250	19.188,00	19.188,00

	TIPO TYPE	CV HP	PVP € BOMBA/Pump
--	--------------	----------	---------------------



VORT- SUMERGIBLES FECALES VORTEX AISI-304

VORT 7 M AUT	0,75	390,00
VORT 10 M AUT	1	451,00
VORT 15 M AUT	1,5	512,00
VORT 15 T	1,5	417,00
VORT 20 T	2	468,00



COMPACTA- SUMERGIBLES VORTEX

COMPACTA 1 M AUT	0,4	375,00
COMPACTA 2 M AUT	0,8	516,00
COMPACTA 2 T	0,8	498,00
COMPACTA 3 M AUT	1	583,00
COMPACTA 3 T	1	567,00
COMPACTA 22 M AUT	0,8	614,00
COMPACTA 22 T	0,8	595,00
COMPACTA 32 M AUT	1	678,00
COMPACTA 32 T	1	663,00
COMPACTA 4 M AUT	1,5	960,00
COMPACTA 4 T	1,5	932,00
COMPACTA 55 M AUT	2	1.096,00
COMPACTA 55 T	2	1.040,00
COMPACTA 6 T	3	1.558,00
COMPACTA PRO 4 T (ATEX)	1,5	1.470,00
COMPACTA PRO 6 T (ATEX)	3	1.669,00



VG- SUMERGIBLES FECALES VORTEX

VG 05 M AUT	0,5	386,00
VG 10 M AUT	1	545,00
VG 10 T	1	501,00
VG 20 M AUT	2	897,00
VG 20 T	2	806,00
VG 30 T	3	914,00
VG 50 T	5	1.431,00



**GRIX- GX- GT
SUMERGIBLES CONTRITURADOR**

GRIX 32-2 C.90 M Aut	1,2	1.118,00
GRIX 32-2 C.90 T	1,2	960,00
GRIX 32-2 C.110 M Aut	1,5	1.510,00
GRIX 32-2 C.110 T	1,5	1.345,00
GX 50-2 C. 220 T	3	2.099,00
GT 50-2 C.165 T + BASE	4,5	4.213,00
GT 50-2 C.170 T + BASE	6	5.307,00
GT 50-2 C.175 T + BASE	8,5	7.147,00
GT 50-2 C.180 T + BASE	10,5	8.042,00
GT 50-2 C.185 T + BASE	13	9.048,00

TIPO TYPE	CV HP	PVP € BOMBA/Pump
--------------	----------	---------------------

HT- SUMERGIBLES AGUAS CARGADAS GRANDES ALTURAS



HT 50-2 C.500	2	2.267,00
HT 50-2 C.501	3	2.439,00
HT 65-2 C.502	4	3.329,00
HT 65-2 C.503	5,5	4.318,00
HT 65-2 C.504	7,5	5.381,00
HT 65-2 C.505	10	5.841,00

M- SUMERGIBLES FECALESTURBINA MONOCANAL

Modelos a 2.850 r.p.m.



M 65-2 C.236	2	2.106,00
M 65-2 C.237	3	2.443,00
M 65-2 C.247	5,5	4.318,00
M 80-2 C.254	7,5	5.445,00
M 80-2 C.257	10	6.194,00
M 80-2 C.267	16	8.905,00
M 80-2 C.268	20	11.033,00
M 80-2 C.269	27	13.010,00
M 80-2 C.270	34	14.563,00
M 80-2 C.271	41	17.505,00

Modelos a 1.450 r.p.m.

M 80-4 C.242	2	2.473,00
M 80-4 C.244	3	3.051,00
M 80-4 C.245	4	3.390,00
M 100-4 C.243	2,2	3.016,00
M 100-4 C.244	3	3.386,00
M 100-4 C.245	4	3.758,00
M 100-4 C.255	5,5	5.108,00
M 100-4 C.256	7,5	5.958,00
M 150-4 C.258	10	8.962,00
M 150-4 C.260	13,5	10.497,00
M 150-4 C.263	22,5	11.677,00
M 150-4 C.264	16	11.889,00
M 150-4 C.265	22	15.800,00
M 150-4 C.275	24	19.089,00
M 150-4 C.280	31	22.104,00
M 150-4 C.285	40	26.747,00
M 150-4 C.290	53,5	33.037,00
M 150-4 C.295	61	38.358,00
M 150-4 C.300	68	39.605,00

VN- SUMERGIBLES VORTEX AISI-316



VN 05 M AUT	0,5	1.060,00
VN 10 M AUT	1	1.493,00
VN 30 T-50	3	2.569,00
VN 50 T-80	5	3.619,00
VN 75 T-80	7,5	4.502,00

*Incluye codo salida / Includes outlet elbow

*Para info técnica consulte nuestra web / For more info see our website

	TIPO TYPE	CV HP	PVP € BOMBA/Pump
--	--------------	----------	---------------------

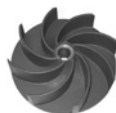

VT- SUMERGIBLES FECALESTURBINA VORTEX

VT 80-4 C.341	1,5	2.146,00
VT 80-4 C.342	1,7	2.319,00
VT 80-4 C.344	3	3.051,00
VT 80-4 C.345	4	3.390,00
VT 100-4 C.349	3	3.386,00
VT 100-4 C.350	4	3.758,00
VT 100-4 C.355	5,5	5.108,00
VT 100-4 C.356	7,5	5.958,00
VT 100-4 C.358	10	6.842,00
VT 100-4 C.362	15	9.412,00
VT 100-4 C.363	20	10.534,00
VT 100-4 C.375	30	18.983,00
VT 100-4 C.380	35	21.998,00
VT 150-4 C.385	40	26.747,00
VT 150-4 C.390	50	33.037,00
VT 150-4 C.395	59	38.358,00



FEKAFOS- KIT ESTACIONES AUTOMÁTICAS

KIT FEKABOX 110	509,00
KIT FEKABOX 200	1.041,00
KIT FEKAFOS 280	1.781,00
KIT FEKAFOS 280 DOBLE	2.537,00
KIT DRENOBOX 600 DOBLE	2.800,00

LOS PRECIOS DE LOS KITS FEKABOX/FEKAFOS NO INCLUYEN LA BOMBA

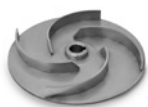

DRX- SUMERGIBLES DRENAJE AISI-304

MINI DRX M	0,33	283,00
MINI DRX M AUT	0,33	304,00
MINI DRX M AUTFIX	0,33	403,00
DISPOSITIVO ASPIRACIÓN MINI DRX (3mm)		12,00
DRX 7 M AUT	0,75	457,00
DRX 10 M AUT	1	491,00
DRX 10 T	1	457,00
DRX 15 M AUT	1,5	542,00
DRX 15 T	1,5	501,00
DRX 20 T	2	559,00



DG- SUMERGIBLES DRENAJE FUNDICIÓN HIERRO

DG 20 T	2	806,00
DG 30 T	3	914,00
DG 50 T	5	1.431,00

*Incluye codo salida / Includes outlet elbow

*Para info técnica consulte nuestra web / For more info see our website

	TIPO TYPE	CV HP	PVP € BOMBA/Pump
--	--------------	----------	---------------------



ZOCALOS DE ACOPLAMIENTO BOMBAS AGUAS FECALES

MINIZOCALO 2"	193,00
ZOCALO DN-65 PN 10	680,00
ZOCALO DN-65 PN 6	501,00
ZOCALO DN-80	992,00
ZOCALO DN-100	1.324,00
ZOCALO DN-150 (sólo para M 150-4 C.258)	1.867,00
ZOCALO DN-150	2.601,00

	TIPO TYPE	PVP € RETENCIÓN	PVP € COMPERTA
--	--------------	--------------------	-------------------



VÁLVULAS PARA AGUAS FECALES

1 1/4" ROSCA	100,00	-
1 1/2" ROSCA	100,00	-
2" ROSCA	128,00	-
2 1/2" ROSCA	188,00	-
DN 50	-	166,00
DN 65	241,00	200,00
DN 80	298,00	236,00
DN 100	426,00	334,00
DN 150	797,00	536,00
DN 200	1.568,00	806,00
DN 250	2.603,00	1.286,00
DN 300	3.904,00	1.790,00

	TIPO TYPE	PVP €
--	--------------	-------

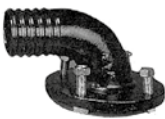

BRIDAS CON CODO A 90° PARA CONEXIÓN ATUBO FLEXIBLE

BRIDA CODO DN 65 PN 6 CUADRADA	164,00
BRIDA CODO DN 65 PN 10 REDONDA	193,00
BRIDA CODO DN 80	222,00
BRIDA CODO DN 100	263,00
BRIDA CODO DN 150	371,00



PINZA CON BRIDA (RECAMBIO PARA ZOCALOS)

PINZA CON BRIDA DN-65 PN-6 CUADRADA	271,00
PINZA CON BRIDA DN-65 PN10 REDONDA	271,00
PINZA CON BRIDA DN-80	316,00
PINZA CON BRIDA DN-100	399,00
PINZA CON BRIDA DN-150	570,00

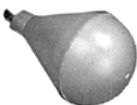

INTERRUPTOR DE NIVEL AGUAS FECALES ECOLOGY

INTERRUPTOR ECOLOGY 6 MTS	70,00
INTERRUPTOR ECOLOGY 15 MTS	107,00
INTERRUPTOR ECOLOGY 20 MTS (ATEX)	210,00



**CUADROS ELÉCTRICOS
Y GRUPOS DE PRESIÓN
/ CONTROL PANELS AND
BOOSTER SETS**

	TIPO TYPE	PVP €
--	--------------	-------



[e]MOTION-VARIADORES DE FRECUENCIA SUELTOS

VARIADOR [e]MOTION MT2-11	707,00
VARIADOR [e]MOTION TT3-11	977,00
VARIADOR [e]MOTION TT3-30 (UP TO 20HP)	1.915,00



[e]JOY- [e]POOL VARIADORES DE VELOCIDAD SUELTOS

VARIADOR DE VELOCIDAD [e]JOY (MT2-11)	798,00
VARIADOR DE VELOCIDAD [e]JOY (TT3-11)	1.015,00
VARIADOR DE VELOCIDAD [e]POOL (TT3-11)	997,00
VARIADOR DE VELOCIDAD [e]POOL (TT3-30)	1.975,00



SOPORTE PARED VARIADOR (MT2-11, TT3-11)	95,00
SOPORTE PARED VARIADOR (TT3-30)	237,00
TRANSDUCTOR DE PRESION 0-10 BAR 4-20mA (2 m CABLE)	117,00
TRANSDUCTOR DE PRESION 0-25 BAR 4-20mA (SIN CABLE)	117,00
TRANSDUCTOR DE PRESION 0-40 BAR 4-20mA (SIN CABLE)	172,00
SONDA TEMPERATURA NTC 47K B=4000 1/4" AISI 316	84,00



CUADROS ELECTRÓNICOS

EASYTRONIC-ONE	307,00
EASYTRONIC-2	405,00

EASYTRONIC es cuadro electrónico que puede usarse tanto para controlar un grupo de presión, un conjunto de bombas de aguas sucias o una instalación con bomba de pozo. Puede funcionar en una instalación monofásica o trifásica y en función de la alimentación suministrada podrá controlar y proteger 1 o 2 bombas monofásica o trifásicas.

EASYTRONIC is an electronic panel that can be used to control a pressure booster set, a set of sewage pumps or an installation with a well pump. It can work in a single-phase or three-phase installation and depending on the power supplied it can control and protect 1 or 2 single-phase or three-phase pumps.



SMART POOL (PARED / WALL)	277,00
SMART POOL PRO (PARED / WALL)	401,00
CUADRO (PANEL) FOCOS LED 50W	151,00
CUADRO (PANEL) FOCOS LED 2x50W	191,00
SONDA (PROBE) TEMPERATURA PT-100 1/4" AISI 316	77,00



Cuadros Monofásicos

C.V.	CUADROS SIMPLES		CUADROS 1TRANSF.		CUADROS 2TRANSF.		CUADROS 3TRANSF.	
	Referencia	P.V.P.	Referencia	P.V.P.	Referencia	P.V.P.	Referencia	P.V.P.
0,25 CV	CPI-S-0,25-M	253,00	CPI-1TR-0,25-M	455,00	CPI-2TR-0,25-M	552,00	CPI-3TR-0,25-M	788,00
0,33 CV	CPI-S-0,33-M	253,00	CPI-1TR-0,33-M	455,00	CPI-2TR-0,33-M	552,00	CPI-3TR-0,33-M	788,00
0,5 CV	CPI-S-0,5-M	253,00	CPI-1TR-0,5-M	456,00	CPI-2TR-0,5-M	553,00	CPI-3TR-0,5-M	788,00
0,75 CV	CPI-S-0,75-M	253,00	CPI-1TR-0,75-M	456,00	CPI-2TR-0,75-M	553,00	CPI-3TR-0,75-M	788,00
1 CV	CPI-S-1-M	253,00	CPI-1TR-1-M	456,00	CPI-2TR-1-M	553,00	CPI-3TR-1-M	788,00
1,5 CV	CPI-S-1,5-M	253,00	CPI-1TR-1,5-M	456,00	CPI-2TR-1,5-M	553,00	CPI-3TR-1,5-M	788,00
2 CV	CPI-S-2-M	280,00	CPI-1TR-2-M	463,00	CPI-2TR-2-M	581,00	CPI-3TR-2-M	816,00

*1 TRANSFORMADOR = 350 W

*2 TRANSFORMADORES = 700 W

*3 TRANSFORMADORES = 700 W + 350 W

Cuadros Trifásicos a 400 V

C.V.	CUADROS SIMPLES		CUADROS 1TRANSF.		CUADROS 2TRANSF.		CUADROS 3TRANSF.	
	Referencia	P.V.P.	Referencia	P.V.P.	Referencia	P.V.P.	Referencia	P.V.P.
0,5 CV	CPI-S-0,5-T3	255,00	CPI-1TR-0,5-T3	457,00	CPI-2TR-0,5-T3	554,00	CPI-3TR-0,5-T3	790,00
0,75 CV	CPI-S-0,75-T3	255,00	CPI-1TR-0,75-T3	457,00	CPI-2TR-0,75-T3	554,00	CPI-3TR-0,75-T3	790,00
1 CV	CPI-S-1-T3	255,00	CPI-1TR-1-T3	457,00	CPI-2TR-1-T3	554,00	CPI-3TR-1-T3	790,00
1,5 CV	CPI-S-1,5-T3	256,00	CPI-1TR-1,5-T3	458,00	CPI-2TR-1,5-T3	555,00	CPI-3TR-1,5-T3	791,00
2 CV	CPI-S-2-T3	256,00	CPI-1TR-2-T3	458,00	CPI-2TR-2-T3	555,00	CPI-3TR-2-T3	791,00
3 CV	CPI-S-3-T3	256,00	CPI-1TR-3-T3	458,00	CPI-2TR-3-T3	555,00	CPI-3TR-3-T3	791,00
4 CV	CPI-S-4-T3	256,00	CPI-1TR-4-T3	458,00	CPI-2TR-4-T3	555,00	CPI-3TR-4-T3	791,00
5,5 CV	CPI-S-5,5-T3	264,00	CPI-1TR-5,5-T3	466,00	CPI-2TR-5,5-T3	563,00	CPI-3TR-5,5-T3	799,00

*1 TRANSFORMADOR = 350 W

*2 TRANSFORMADORES = 700 W

*3 TRANSFORMADORES = 700 W + 350 W

Cuadros Trifásicos a 400 V



CUADROS CONTROL BOMBA + BATERIA DE VALVULAS	
Referencia	P.V.P.
CUADRO PISCINA PUBLICA (4 VALVULAS) ARR. DIRECTO	2.128,00
CUADRO PISCINA PUBLICA (5 VALVULAS) ARR. DIRECTO	2.193,00
CUADRO PISCINA PUBLICA (4 VALVULAS) ARR. ESTRELLA-TRIANGULO	2.390,00
CUADRO PISCINA PUBLICA (5 VALVULAS) ARR. ESTRELLA-TRIANGULO	2.459,00

CUADROS BOMBAS SUMERGIBLES

CUADROS DIGITALES SIN SONDAS

C.V.	CUADROS DIGITALES SIN SONDAS		
	Amperaje	Referencia	P.V.P.
0,5-2 CV	CUADRO DIGITAL MONOFASICO 0,5 - 2 CV		261,00
0,5-5,5 CV	CUADRO DIGITAL TRIFASICO 0,5 - 5,5 CV		276,00



CUADROS CON SONDAS MONOFÁSICOS

C.V.	CUADROS CON SONDAS POZO		
	Amperaje	Referencia	P.V.P.
0,75-1 CV	4 - 6 A	CSP - 1 - M	188,00
1,5 CV	7 - 10 A	CSP - 1,5 - M	188,00
2 CV	9 - 13 A	CSP - 2 - M	188,00

CUADROS SIN SONDAS MONOFÁSICOS

C.V.	CUADROS SOLO PROTECCIÓN BOMBA		
	Amperaje	Referencia	P.V.P.
1	4 - 6 A	CS-1-M	112,00
1,5	7 - 10 A	CS-1,5-M	112,00
2	9 - 13 A	CS-2-M	112,00

CUADROS CON SONDAS TRIFÁSICOS A 400 V

C.V.	CUADROS CON SONDAS POZO		
	Amperaje	Referencia	P.V.P.
0,75-1 CV	1,6 - 2,5 A	CSP - 1 - T3	196,00
1,5 - 2 CV	2,5 - 4 A	CSP - 2 - T3	196,00
3 - 4 CV	5,5 - 8 A	CSP - 4 - T3	196,00
5,5 CV	9 - 13 A	CSP - 5,5 - T3	196,00

CUADROS SIN SONDAS TRIFÁSICOS A 400 V

C.V.	CUADROS SOLO PROTECCIÓN BOMBA		
	Amperaje	Referencia	P.V.P.
1	1,6 - 2,5 A	CS-1-T3	122,00
2	2,5 - 4 A	CS-2-T3	122,00
4	5,5 - 8 A	CS-4-T3	122,00
5,5	9 - 13 A	CS-5,5-T3	122,00

SUPLEMENTOS OPCIONALES PARA CUADROS ELECTRICOS

ESTOS SUPLEMENTOS NUNCA SERÁN APLICABLES SOBRE LA SERIE DE CUADROS CSP

En caso de incluir más de un suplemento por cuadro rogamos consulten nuestro Departamento Técnico.

Descripción

	P.V.P.
Suplemento Protección Secuencia y Fallo de Fases	108,00
Suplemento Reloj Horario para Control de Electroválvulas	132,00
Suplemento Arranque por señal Externa de Programador	59,00
Suplemento Sondas Pozo (incluye relé más 3 sondas pozo)	133,00
Suplemento Sondas Pozo-Depósito (incluye relé más 6 sondas pozo)	241,00

* Su coste varía según el modelo de cuadro solicitado, rogamos consulten.

OTROS SUPLEMENTO ROGAMOS CONSULTEN NUESTRO DEPT. TÉCNICO

CUADROS VARIO SYSTEM CON VARIADOR DE FRECUENCIA

CUADROS TRIFÁSICOS A 400V



CUADROS VARIO SYSTEM ALTERNADOS

CUADROS VARIO 1 BOMBA (Sin Función Presostatos)			
Referencia	C.V.	Int. Máx.	P.V.P.
C1VF-1,5-T3	1,5	3,4 A	1.699,00
C1VF-2-T3	2	4,1 A	1.925,00
C1VF-3-T3	3	5,7 A	2.017,00
C1VF-4-T3	4	7,3 A	2.156,00
C1VF-5,5-T3	5,5	9,5 A	2.404,00
C1VF-7,5-T3	7,5	12,7 A	2.634,00
C1VF-10-T3	10	18 A	3.104,00
C1VF-15-T3	15	26 A	3.592,00
C1VF-20-T3	20	33 A	4.400,00
C1VF-25-T3	25	39 A	5.078,00
C1VF-30-T3	30	46 A	5.837,00
C1VF-40-T3	40	62 A	6.577,00
C1VF-50-T3	50	73 A	7.598,00

CUADROS VARIO 2 BOMBAS ALTERNADAS			
Referencia	C.V.	Int. Máx.	P.V.P.
C2VF-1,5-T3A	1,5	3,4 A	2.253,00
C2VF-2-T3A	2	4,1 A	2.479,00
C2VF-3-T3A	3	5,7 A	2.571,00
C2VF-4-T3A	4	7,3 A	2.711,00
C2VF-5,5-T3A	5,5	9,5 A	2.994,00
C2VF-7,5-T3A	7,5	12,7 A	3.909,00
C2VF-10-T3A	10	18 A	4.476,00
C2VF-15-T3A	15	26 A	5.254,00
C2VF-20-T3A	20	33 A	6.610,00
C2VF-25-T3A	25	39 A	7.305,00
C2VF-30-T3A	30	46 A	8.496,00
C2VF-40-T3A	40	62 A	9.271,00
C2VF-50-T3A	50	73 A	11.064,00

CUADROS VARIO 3 BOMBAS ALTERNADAS			
Referencia	C.V.	Int. Máx.	P.V.P.
C3VF-1,5-T3A	1,5	3,4 A	2.960,00
C3VF-2-T3A	2	4,1 A	3.187,00
C3VF-3-T3A	3	5,7 A	3.279,00
C3VF-4-T3A	4	7,3 A	3.424,00
C3VF-5,5-T3A	5,5	9,5 A	3.732,00
C3VF-7,5-T3A	7,5	12,7 A	4.640,00
C3VF-10-T3A	10	18 A	5.333,00
C3VF-15-T3A	15	26 A	6.235,00
C3VF-20-T3A	20	33 A	8.261,00
C3VF-25-T3A	25	39 A	8.979,00
C3VF-30-T3A	30	46 A	10.372,00
C3VF-40-T3A	40	62 A	11.484,00
C3VF-50-T3A	50	73 A	13.486,00

CUADROS VARIO 4 BOMBAS ALTERNADAS			
Referencia	C.V.	Int. Máx.	P.V.P.
C4VF-1,5-T3A	1,5	3,4 A	3.750,00
C4VF-2-T3A	2	4,1 A	3.975,00
C4VF-3-T3A	3	5,7 A	4.073,00
C4VF-4-T3A	4	7,3 A	4.220,00
C4VF-5,5-T3A	5,5	9,5 A	4.540,00
C4VF-7,5-T3A	7,5	12,7 A	5.968,00
C4VF-10-T3A	10	18 A	6.389,00
C4VF-15-T3A	15	26 A	7.456,00
C4VF-20-T3A	20	33 A	9.107,00
C4VF-25-T3A	25	39 A	10.004,00
C4VF-30-T3A	30	46 A	14.011,00
C4VF-40-T3A	40	62 A	14.948,00
C4VF-50-T3A	50	73 A	17.250,00

CUADROS VARIO SYSTEM MULTIMASTER

CUADRO VARIO 2 BOMBAS MULTIMASTER			
Referencia	C.V.	Int. Máx.	P.V.P.
C2VF-1,5-T3MM	1,5	3,4 A	2.624,00
C2VF-2-T3MM	2	4,1 A	3.075,00
C2VF-3-T3MM	3	5,7 A	3.259,00
C2VF-4-T3MM	4	7,3 A	3.541,00
C2VF-5,5-T3MM	5,5	9,5 A	4.036,00
C2VF-7,5-T3MM	7,5	12,7 A	4.413,00
C2VF-10-T3MM	10	18 A	5.475,00
C2VF-15-T3MM	15	26 A	6.462,00
C2VF-20-T3MM	20	33 A	8.007,00
C2VF-25-T3MM	25	39 A	9.434,00
C2VF-30-T3MM	30	46 A	10.894,00
C2VF-40-T3MM	40	62 A	CONSULTAR
C2VF-50-T3MM	50	73 A	CONSULTAR

CUADRO VARIO 3 BOMBAS MULTIMASTER			
Referencia	C.V.	Int. Máx.	P.V.P.
C3VF-1,5-T3MM	1,5	3,4 A	3.846,00
C3VF-2-T3MM	2	4,1 A	4.522,00
C3VF-3-T3MM	3	5,7 A	4.801,00
C3VF-4-T3MM	4	7,3 A	5.228,00
C3VF-5,5-T3MM	5,5	9,5 A	5.975,00
C3VF-7,5-T3MM	7,5	12,7 A	6.534,00
C3VF-10-T3MM	10	18 A	8.010,00
C3VF-15-T3MM	15	26 A	9.487,00
C3VF-20-T3MM	20	33 A	11.673,00
C3VF-25-T3MM	25	39 A	13.714,00
C3VF-30-T3MM	30	46 A	16.070,00
C3VF-40-T3MM	40	62 A	CONSULTAR
C3VF-50-T3MM	50	73 A	CONSULTAR

CUADRO VARIO 4 BOMBAS MULTIMASTER			
Referencia	C.V.	Int. Máx.	P.V.P.
C4VF-1,5-T3MM	1,5	3,4 A	5.024,00
C4VF-2-T3MM	2	4,1 A	5.929,00
C4VF-3-T3MM	3	5,7 A	6.297,00
C4VF-4-T3MM	4	7,3 A	6.870,00
C4VF-5,5-T3MM	5,5	9,5 A	7.862,00
C4VF-7,5-T3MM	7,5	12,7 A	8.622,00
C4VF-10-T3MM	10	18 A	10.723,00
C4VF-15-T3MM	15	26 A	12.636,00
C4VF-20-T3MM	20	33 A	15.571,00
C4VF-25-T3MM	25	39 A	18.280,00
C4VF-30-T3MM	30	46 A	21.537,00
C4VF-40-T3MM	40	62 A	CONSULTAR
C4VF-50-T3MM	50	73 A	CONSULTAR

EL PRECIO INCLUYE TRANSDUCTOR DE PRESION 4-20mA 0-10 Bar
THE PRICE INCLUDES PRESSURE TRANSDUCER 4-20mA 0-10 Bar



CUADROS ELÉCTRICOS CON ARRANCADORES PROGRESIVOS EQUIPOS DE PRESIÓN

Cuadros Trifásicos a 400 V

C.V.	CUADROS DE 1 BOMBA		CUADROS DE 2 BOMBAS		CUADROS DE 3 BOMBAS		CUADROS DE 4 BOMBAS	
	Referencia	P.V.P.	Referencia	P.V.P.	Referencia	P.V.P.	Referencia	P.V.P.
3 CV	C1PAR-3-T3	783,00	C2PAR-3-T3	1.361,00	C3PAR-3-T3	1.967,00	C4PAR-3-T3	2.559,00
4 CV	C1PAR-4-T3	783,00	C2PAR-4-T3	1.361,00	C3PAR-4-T3	1.968,00	C4PAR-4-T3	2.568,00
5,5 CV	C1PAR-5,5-T3	783,00	C2PAR-5,5-T3	1.368,00	C3PAR-5,5-T3	1.986,00	C4PAR-5,5-T3	2.571,00
7,5 CV	C1PAR-7,5-T3	777,00	C2PAR-7,5-T3	1.366,00	C3PAR-7,5-T3	1.991,00	C4PAR-7,5-T3	2.630,00
10 CV	C1PAR-10-T3	884,00	C2PAR-10-T3	1.605,00	C3PAR-10-T3	2.357,00	C4PAR-10-T3	3.061,00
12,5 CV	C1PAR-12,5-T3	908,00	C2PAR-12,5-T3	1.660,00	C3PAR-12,5-T3	2.461,00	C4PAR-12,5-T3	3.160,00
15 CV	C1PAR-15-T3	923,00	C2PAR-15-T3	1.719,00	C3PAR-15-T3	2.531,00	C4PAR-15-T3	3.228,00
20 CV	C1PAR-20-T3	1.194,00	C2PAR-20-T3	2.148,00	C3PAR-20-T3	3.287,00	C4PAR-20-T3	4.149,00
25 CV	C1PAR-25-T3	1.347,00	C2PAR-25-T3	2.577,00	C3PAR-25-T3	3.761,00	C4PAR-25-T3	5.061,00
30 CV	C1PAR-30-T3	1.757,00	C2PAR-30-T3	3.353,00	C3PAR-30-T3	5.043,00	C4PAR-30-T3	6.789,00

CUADROS ELÉCTRICOS CON ARRANCADORES PROGRESIVO AGUAS SUCIAS

Cuadros Trifásicos a 400 V

C.V.	CUADROS DE 1 BOMBA		CUADROS DE 2 BOMBAS		CUADROS DE 3 BOMBAS		CUADROS DE 4 BOMBAS	
	Referencia	P.V.P.	Referencia	P.V.P.	Referencia	P.V.P.	Referencia	P.V.P.
3 CV	C1FAR-3-T3	828,00	C2FAR-3-T3	1.416,00	C3FAR-3-T3	2.040,00	C4FAR-3-T3	2.648,00
4 CV	C1FAR-4-T3	828,00	C2FAR-4-T3	1.416,00	C3FAR-4-T3	2.040,00	C4FAR-4-T3	2.655,00
5,5 CV	C1FAR-5,5-T3	828,00	C2FAR-5,5-T3	1.419,00	C3FAR-5,5-T3	2.062,00	C4FAR-5,5-T3	2.659,00
7,5 CV	C1FAR-7,5-T3	823,00	C2FAR-7,5-T3	1.421,00	C3FAR-7,5-T3	2.068,00	C4FAR-7,5-T3	2.718,00
10 CV	C1FAR-10-T3	928,00	C2FAR-10-T3	1.659,00	C3FAR-10-T3	2.428,00	C4FAR-10-T3	3.149,00
12,5 CV	C1FAR-12,5-T3	953,00	C2FAR-12,5-T3	1.715,00	C3FAR-12,5-T3	2.532,00	C4FAR-12,5-T3	3.248,00
15 CV	C1FAR-15-T3	968,00	C2FAR-15-T3	1.773,00	C3FAR-15-T3	2.604,00	C4FAR-15-T3	3.315,00
20 CV	C1FAR-20-T3	1.229,00	C2FAR-20-T3	2.184,00	C3FAR-20-T3	3.323,00	C4FAR-20-T3	4.185,00
25 CV	C1FAR-25-T3	1.393,00	C2FAR-25-T3	2.631,00	C3FAR-25-T3	3.835,00	C4FAR-25-T3	5.082,00
30 CV	C1FAR-30-T3	1.796,00	C2FAR-30-T3	3.387,00	C3FAR-30-T3	5.078,00	C4FAR-30-T3	6.824,00



Más info:

CUADRO ELECTRONICO PARA 1Y 2 BOMBAS

EASYTRONIC-ONE
EASYTRONIC-2

307,00
405,00

EASYTRONIC es cuadro electrónico que puede usarse tanto para controlar un grupo de presión, un conjunto de bombas de aguas sucias o una instalación con bomba de pozo. Puede funcionar en una instalación monofásica o trifásica y en función de la alimentación suministrada podrá controlar y proteger 1 o 2 bombas monofásica o trifásicas.

EASYTRONIC is an electronic panel that can be used to control a pressure booster set, a set of sewage pumps or an installation with a well pump. It can work in a single-phase or three-phase installation and depending on the power supplied it can control and protect 1 or 2 single-phase or three-phase pumps.

CUADROS ELÉCTRICOS PARA EQUIPOS DE PRESIÓN

Cuadros Monofásicos



C.V.	CUADROS 1 BOMBA		CUADROS 2 BOMBA	
	Referencia	P.V.P.	Referencia	P.V.P.
0,5 CV	C1PD-0,5-M	328,00	C2PD-0,5-M	538,00
0,75-1 CV	C1PD-1-M	328,00	C2PD-1-M	538,00
1,5 CV	C1PD-1,5-M	346,00	C2PD-1,5-M	574,00
2 CV	C1PD-2-M	358,00	C2PD-2-M	578,00
3 CV	C1PD-3-M	372,00	C2PD-3-M	626,00

Cuadros Trifásicos a 400 V

C.V.	CUADROS 1 BOMBA		CUADROS 2 BOMBA		CUADROS 3 BOMBA		CUADROS 4 BOMBA	
	Referencia	P.V.P.	Referencia	P.V.P.	Referencia	P.V.P.	Referencia	P.V.P.
0,5 CV	C1PD-0,5-T3	330,00	C2PD-0,5-T3	545,00	C3PD-0,5-T3	997,00	C4PD-0,5-T3	1.225,00
0,75-1 CV	C1PD-1-T3	330,00	C2PD-1-T3	545,00	C3PD-1-T3	997,00	C4PD-1-T3	1.225,00
1,5 CV	C1PD-1,5-T3	330,00	C2PD-1,5-T3	545,00	C3PD-1,5-T3	997,00	C4PD-1,5-T3	1.225,00
2 CV	C1PD-2-T3	330,00	C2PD-2-T3	545,00	C3PD-2-T3	999,00	C4PD-2-T3	1.225,00
3 CV	C1PD-3-T3	330,00	C2PD-3-T3	545,00	C3PD-3-T3	999,00	C4PD-3-T3	1.228,00
4 CV	C1PD-4-T3	331,00	C2PD-4-T3	546,00	C3PD-4-T3	1.001,00	C4PD-4-T3	1.242,00
5,5 CV	C1PD-5,5-T3	348,00	C2PD-5,5-T3	581,00	C3PD-5,5-T3	1.065,00	C4PD-5,5-T3	1.314,00
7,5 CV	C1PET-7,5-T3	713,00	C2PET-7,5-T3	1.114,00	C3PET-7,5-T3	1.599,00	C4PET-7,5-T3	2.148,00
10 CV	C1PET-10-T3	723,00	C2PET-10-T3	1.171,00	C3PET-10-T3	1.629,00	C4PET-10-T3	2.163,00
12,5 CV	C1PET-12,5-T3	754,00	C2PET-12,5-T3	1.233,00	C3PET-12,5-T3	1.720,00	C4PET-12,5-T3	2.355,00
15 CV	C1PET-15-T3	845,00	C2PET-15-T3	1.376,00	C3PET-15-T3	1.948,00	C4PET-15-T3	2.606,00
20 CV	C1PET-20-T3	1.033,00	C2PET-20-T3	1.684,00	C3PET-20-T3	2.719,00	C4PET-20-T3	3.624,00
25 CV	C1PET-25-T3	1.061,00	C2PET-25-T3	1.889,00	C3PET-25-T3	2.845,00	C4PET-25-T3	4.052,00
30 CV	C1PET-30-T3	1.157,00	C2PET-30-T3	2.006,00	C3PET-30-T3	3.152,00	C4PET-30-T3	4.539,00
40 CV	C1PET-40-T3	1.362,00	C2PET-40-T3	2.454,00	C3PET-40-T3	3.894,00	C4PET-40-T3	5.314,00
50 CV	C1PET-50-T3	1.594,00	C2PET-50-T3	3.172,00	C3PET-50-T3	4.780,00	C4PET-50-T3	6.156,00
60 CV	C1PET-60-T3	1.732,00	C2PET-60-T3	3.840,00	C3PET-60-T3	4.909,00	C4PET-60-T3	6.492,00

TIPO
TYPE

PVP €



CUADRO ELECTRONICO PARA 1Y 2 BOMBAS

 EASYTRONIC-ONE
EASYTRONIC-2

307,00
405,00

EASYTRONIC es cuadro electrónico que puede usarse tanto para controlar un grupo de presión, un conjunto de bombas de aguas sucias o una instalación con bomba de pozo. Puede funcionar en una instalación monofásica o trifásica y en función de la alimentación suministrada podrá controlar y proteger 1 o 2 bombas monofásica o trifásicas.

EASYTRONIC is an electronic panel that can be used to control a pressure booster set, a set of sewage pumps or an installation with a well pump. It can work in a single-phase or three-phase installation and depending on the power supplied it can control and protect 1 or 2 single-phase or three-phase pumps.



Más info:

CUADROS ELECTRICOS PARA BOMBAS DE AGUAS SUCIAS

Cuadros Monofásicos

C.V.	CUADROS 1 BOMBA		CUADROS 2 BOMBA	
	Referencia	P.V.P.	Referencia	P.V.P.
0,5 CV	C1FD-0,5-M	363,00	C2FD-0,5-M	578,00
0,75-1 CV	C1FD-1-M	363,00	C2FD-1-M	578,00
1,5 CV	C1FD-1,5-M	381,00	C2FD-1,5-M	613,00
2 CV	C1FD-2-M	393,00	C2FD-2-M	618,00
3 CV	C1FD-3-M	408,00	C2FD-3-M	661,00



Cuadros Trifásicos a 400 V

C.V.	CUADROS 1 BOMBA		CUADROS 2 BOMBA		CUADROS 3 BOMBA		CUADROS 4 BOMBA	
	Referencia	P.V.P.	Referencia	P.V.P.	Referencia	P.V.P.	Referencia	P.V.P.
0,5 CV	C1FD-0,5-T3	366,00	C2FD-0,5-T3	580,00	C3FD-0,5-T3	1.032,00	C4FD-0,5-T3	1.260,00
0,75-1 CV	C1FD-1-T3	366,00	C2FD-1-T3	580,00	C3FD-1-T3	1.032,00	C4FD-1-T3	1.260,00
1,5 CV	C1FD-1,5-T3	366,00	C2FD-1,5-T3	580,00	C3FD-1,5-T3	1.032,00	C4FD-1,5-T3	1.260,00
2 CV	C1FD-2-T3	366,00	C2FD-2-T3	580,00	C3FD-2-T3	1.034,00	C4FD-2-T3	1.260,00
3 CV	C1FD-3-T3	366,00	C2FD-3-T3	580,00	C3FD-3-T3	1.035,00	C4FD-3-T3	1.263,00
4 CV	C1FD-4-T3	366,00	C2FD-4-T3	581,00	C3FD-4-T3	1.036,00	C4FD-4-T3	1.277,00
5,5 CV	C1FD-5,5-T3	384,00	C2FD-5,5-T3	616,00	C3FD-5,5-T3	1.101,00	C4FD-5,5-T3	1.349,00
7,5 CV	C1FET-7,5-T3	748,00	C2FET-7,5-T3	1.149,00	C3FET-7,5-T3	1.634,00	C4FET-7,5-T3	2.183,00
10 CV	C1FET-10-T3	758,00	C2FET-10-T3	1.206,00	C3FET-10-T3	1.665,00	C4FET-10-T3	2.199,00
12,5 CV	C1FET-12,5-T3	789,00	C2FET-12,5-T3	1.268,00	C3FET-12,5-T3	1.755,00	C4FET-12,5-T3	2.390,00
15 CV	C1FET-15-T3	881,00	C2FET-15-T3	1.412,00	C3FET-15-T3	1.984,00	C4FET-15-T3	2.640,00
20 CV	C1FET-20-T3	1.068,00	C2FET-20-T3	1.719,00	C3FET-20-T3	2.754,00	C4FET-20-T3	3.659,00
25 CV	C1FET-25-T3	1.096,00	C2FET-25-T3	1.924,00	C3FET-25-T3	2.880,00	C4FET-25-T3	4.087,00
30 CV	C1FET-30-T3	1.192,00	C2FET-30-T3	2.041,00	C3FET-30-T3	3.187,00	C4FET-30-T3	4.574,00
40 CV	C1FET-40-T3	1.379,00	C2FET-40-T3	2.470,00	C3FET-40-T3	3.910,00	C4FET-40-T3	5.330,00
50 CV	C1FET-50-T3	1.610,00	C2FET-50-T3	3.188,00	C3FET-50-T3	4.796,00	C4FET-50-T3	6.172,00
60 CV	C1FET-60-T3	1.748,00	C2FET-60-T3	3.855,00	C3FET-60-T3	4.925,00	C4FET-60-T3	6.508,00

**INCORPORAN ALARMA ACÚSTICA Y VISUAL DE SERIE
INCLUDE ACOUSTIC AND VISUAL ALARM AS A STANDARD**

	TIPO TYPE	PVP €
--	--------------	-------



**CUADROS CONTRAINCENDIOS
MULTINORMA CON JOCKEY ELECTRICOS A 400V**

CUADRO MULTINORMA 7,5CV + JOCKEY	CONSULTAR
CUADRO MULTINORMA 10CV + JOCKEY	CONSULTAR
CUADRO MULTINORMA 10CV + JOCKEY	CONSULTAR
CUADRO MULTINORMA 12,5CV + JOCKEY	CONSULTAR
CUADRO MULTINORMA 15CV + JOCKEY	CONSULTAR
CUADRO MULTINORMA 20CV + JOCKEY	CONSULTAR
CUADRO MULTINORMA 25CV + JOCKEY	CONSULTAR
CUADRO MULTINORMA 30CV + JOCKEY	CONSULTAR
CUADRO MULTINORMA 40CV + JOCKEY	CONSULTAR
CUADRO MULTINORMA 50CV + JOCKEY	CONSULTAR
CUADRO MULTINORMA 60CV + JOCKEY	CONSULTAR
CUADRO MULTINORMA 75CV + JOCKEY	CONSULTAR
CUADRO MULTINORMA 100CV + JOCKEY	CONSULTAR
CUADRO MULTINORMA 125CV + JOCKEY	CONSULTAR
CUADRO MULTINORMA 150CV + JOCKEY	CONSULTAR

** Las bombas jockey siempre son con arranque directo.

** En el momento de pasar el pedido rogamos especifique consumo (A) de la bomba jockey.

PARA CUADROS DE OTRAS NORMATIVAS, CONSULTEN NUESTRO DEPARTAMENTO COMERCIAL

	TIPO TYPE	PVP € 1 BOMBA	PVP € 2 BOMBAS
--	--------------	------------------	-------------------

EASYTRONIC- EQUIPOS DE PRESION 1Y 2 BOMBAS



EASYTRONIC SIGMA 102 M		1.039,00	1.762,00
EASYTRONIC SIGMA 103 M		1.031,00	1.747,00
EASYTRONIC SIGMA 104 M		1.044,00	1.769,00
EASYTRONIC SIGMA 105 M		1.066,00	1.817,00
EASYTRONIC SIGMA 105 T		1.068,00	1.819,00
EASYTRONIC SIGMA 202 M		1.131,00	1.943,00
EASYTRONIC SIGMA 203 M		1.122,00	1.928,00
EASYTRONIC SIGMA 204 M		1.145,00	1.973,00
EASYTRONIC SIGMA 205 M		1.162,00	2.008,00
EASYTRONIC SIGMA 205 T		1.162,00	2.007,00
EASYTRONIC SIGMA 303 M		1.311,00	2.304,00
EASYTRONIC SIGMA 303 T		1.295,00	2.272,00
EASYTRONIC SIGMA 304 M		1.327,00	2.335,00
EASYTRONIC SIGMA 304 T		1.310,00	2.301,00
EASYTRONIC SIGMA 305 M		1.344,00	2.372,00
EASYTRONIC SIGMA 305 T		1.327,00	2.338,00
EASYTRONIC SIGMA 306 T		1.382,00	2.383,00
EASYTRONIC SIGMA 307 T		1.475,00	2.416,00
EASYTRONIC SIGMA 403 M		1.333,00	2.374,00
EASYTRONIC SIGMA 403 T		1.319,00	2.347,00
EASYTRONIC SIGMA 404 T		1.456,00	2.403,00

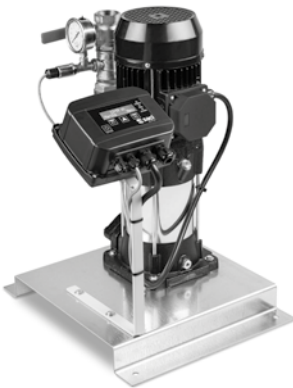

EASYTRONIC V-NOX 303 M		1.342,00	2.367,00
EASYTRONIC V-NOX 303 T		1.326,00	2.335,00
EASYTRONIC V-NOX 304 M		1.358,00	2.399,00
EASYTRONIC V-NOX 304 T		1.342,00	2.365,00
EASYTRONIC V-NOX 305 M		1.376,00	2.436,00
EASYTRONIC V-NOX 305 T		1.358,00	2.402,00
EASYTRONIC V-NOX 306 T		1.414,00	2.510,00
EASYTRONIC V-NOX 307 T		1.431,00	2.545,00
EASYTRONIC V-NOX 308 T		1.586,00	2.855,00
EASYTRONIC V-NOX 309 T		1.629,00	2.919,00
EASYTRONIC V-NOX 310 T		1.694,00	3.047,00
EASYTRONIC V-NOX 403 T		1.378,00	2.466,00
EASYTRONIC V-NOX 404 T		1.439,00	2.587,00
EASYTRONIC V-NOX 405 T		1.595,00	2.898,00
EASYTRONIC V-NOX 406 T		1.622,00	2.950,00
EASYTRONIC V-NOX 407 T		1.688,00	3.083,00



EASYTRONIC XV-F 5-8 T		1.650,00	2.988,00
EASYTRONIC XV-F 5-10 T		1.756,00	3.200,00
EASYTRONIC XV-F 5-14 T		1.909,00	3.507,00
EASYTRONIC XV-F 5-16 T		1.959,00	3.607,00
EASYTRONIC XV-F 5-20 T		2.199,00	4.060,00
EASYTRONIC XV-F 5-29 T		2.719,00	5.118,00
EASYTRONIC XV-F 10-6 T		1.976,00	3.678,00
EASYTRONIC XV-F 10-9 T		2.261,00	4.248,00
EASYTRONIC XV-F 10-10 T		2.384,00	4.493,00
EASYTRONIC XV-F 10-12 T		2.466,00	4.635,00
EASYTRONIC XV-F 15-5 T		2.390,00	4.774,00

	TIPO TYPE	PVP € 1 BOMBA	PVP € 2 BOMBAS	PVP € 3 BOMBAS	PVP € 4 BOMBAS
--	--------------	------------------	-------------------	-------------------	-------------------

[e]NOX- EQUIPOS DE PRESIÓN

EQUIPO [e]NOX 306 (MT2)*	1.958,00	3.893,00	5.799,00	7.953,00
EQUIPO [e]NOX 310 (TT3)*	2.574,00	4.827,00	6.985,00	9.550,00
EQUIPO [e]NOX 407 (TT3)*	2.460,00	4.768,00	7.654,00	9.724,00

*Variador de frecuencia + motores de imanes permanentes

*Variable frequency drive + permanent magnet motors



[e]MOTION- EQUIPOS DE PRESIÓN

[e]motion SIGMA 105 (MT2)	1.364,00	2.625,00	4.095,00	5.291,00
[e]motion SIGMA 205 (MT2)	1.484,00	2.866,00	4.420,00	5.722,00
[e]motion SIGMA 303 (MT2)	1.530,00	2.967,00	4.524,00	6.068,00
[e]motion SIGMA 304 (MT2)	1.548,00	2.994,00	4.563,00	6.123,00
[e]motion SIGMA 305 (MT2)	1.560,00	3.039,00	4.632,00	6.213,00
[e]motion SIGMA 306 (MT2)	1.606,00	3.095,00	4.783,00	6.413,00
[e]motion SIGMA 307 (MT2)	1.666,00	3.133,00	4.835,00	6.485,00
[e]motion SIGMA 403 (MT2)	1.543,00	3.099,00	5.220,00	6.343,00
[e]motion SIGMA 404 (MT2)	1.670,00	3.168,00	5.389,00	6.567,00

[e]motion V-NOX 303 (MT2)	1.595,00	3.044,00	4.662,00	6.207,00
[e]motion V-NOX 304 (MT2)	1.613,00	3.080,00	4.715,00	6.245,00
[e]motion V-NOX 304 (TT3) ESP.	1.712,00	3.278,00	5.012,00	6.641,00
[e]motion V-NOX 305 (MT2)	1.631,00	3.116,00	4.769,00	6.353,00
[e]motion V-NOX 305 (TT3) ESP.	1.730,00	3.314,00	5.066,00	6.749,00
[e]motion V-NOX 306 (MT2)	1.674,00	3.203,00	4.900,00	6.557,00
[e]motion V-NOX 306 (TT3) ESP.	1.773,00	3.401,00	5.197,00	6.953,00
[e]motion V-NOX 307 (MT2)	1.697,00	3.247,00	4.963,00	6.632,00
[e]motion V-NOX 307 (TT3) ESP.	1.796,00	3.445,00	5.260,00	7.028,00
[e]motion V-NOX 308 (TT3)	2.044,00	3.937,00	6.005,00	7.779,00
[e]motion V-NOX 309 (TT3)	2.069,00	4.078,00	6.012,00	7.854,00
[e]motion V-NOX 310 (TT3)	2.212,00	4.172,00	6.133,00	8.070,00

[e]motion V-NOX 403 (MT2)	1.610,00	3.152,00	5.206,00	6.483,00
[e]motion V-NOX 404 (MT2)	1.656,00	3.267,00	5.375,00	6.710,00
[e]motion V-NOX 405 (TT3)	2.010,00	3.861,00	6.268,00	7.900,00
[e]motion V-NOX 406 (TT3)	2.139,00	3.899,00	6.326,00	7.978,00
[e]motion V-NOX 407 (TT3)	2.190,00	4.024,00	6.511,00	8.225,00



TIPO TYPE	PVP € 1 BOMBA	PVP € 2 BOMBAS	PVP € 3 BOMBAS	PVP € 4 BOMBAS
--------------	------------------	-------------------	-------------------	-------------------

[e]MOTION- EQUIPOS DE PRESIÓN

[e]motion XV-F 5-8 (MT2)	1.980,00	3.850,00	5.793,00	7.487,00
[e]motion XV-F 5-10 (MT2)	2.086,00	4.062,00	6.114,00	7.914,00
[e]motion XV-F 5-14 (MT2)	2.238,00	4.366,00	6.570,00	8.523,00
[e]motion XV-F 5-16 (MT2)	2.393,00	4.574,00	6.683,00	8.688,00
[e]motion XV-F 5-20 (TT3)	2.738,00	5.263,00	7.721,00	10.070,00
[e]motion XV-F 5-29 (TT3)	3.195,00	6.253,00	9.258,00	12.156,00
[e]motion XV-F 5-36 (TT3-30)	4.776,00	9.371,00	13.818,00	18.891,00
[e]motion XV-F 10-6 (MT2)	2.314,00	4.515,00	6.794,00	9.061,00
[e]motion XV-F 10-9 (TT3)	2.669,00	5.225,00	7.860,00	10.482,00
[e]motion XV-F 10-10 (TT3)	2.898,00	5.583,00	8.200,00	10.951,00
[e]motion XV-F 10-12 (TT3)	3.022,00	5.827,00	8.567,00	11.440,00
[e]motion XV-F 10-16 (TT3-30)	4.623,00	8.943,00	13.106,00	18.175,00
[e]motion XV-F 10-22 (TT3-30)	5.189,00	10.226,00	14.299,00	19.841,00
[e]motion XV-F 15-5 (TT3)	2.813,00	5.729,00	8.424,00	11.666,00
[e]motion XV-F 15-7 (TT3-30)	4.428,00	8.800,00	13.146,00	18.024,00
[e]motion XV-F 15-9 (TT3-30)	4.743,00	9.298,00	13.658,00	18.716,00
[e]motion XV-F 15-14 (TT3-30)	6.097,00	12.060,00	18.040,00	24.398,00
[e]motion XV-F 15-17 (TT3-30)	6.444,00	12.842,00	19.119,00	25.498,00
[e]motion XV-F 20-5 (TT3-30)	4.261,00	8.464,00	12.725,00	17.352,00
[e]motion XV-F 20-7 (TT3-30)	4.625,00	9.088,00	13.438,00	18.325,00
[e]motion XV-F 20-10 (TT3-30)	5.744,00	11.438,00	16.847,00	22.457,00
[e]motion XV-F 20-14 (TT3-30)	6.475,00	13.030,00	19.299,00	25.736,00
[e]motion XV-F 32-3 (TT3-30)	5.082,00	10.314,00	15.446,00	20.439,00
[e]motion XV-F 32-4 (TT3-30)	5.344,00	10.839,00	16.234,00	21.491,00
[e]motion XV-F 32-6 (TT3-30)	6.962,00	13.699,00	20.095,00	26.816,00
[e]motion XV-F 32-8 (TT3-30)	7.598,00	14.972,00	22.005,00	29.327,00
[e]motion XV-F 45-2 (TT3-30)	5.337,00	10.889,00	16.360,00	21.768,00
[e]motion XV-F 45-3 (TT3-30)	6.704,00	13.348,00	19.990,00	26.753,00
[e]motion XV-F 45-4 (TT3-30)	7.244,00	14.297,00	21.159,00	28.370,00
[e]motion XV-F 64-2 (TT3-30)	6.623,00	13.269,00	19.920,00	26.640,00
[e]motion XV-F 64-3-1 (TT3-30)	7.232,00	14.452,00	21.745,00	29.007,00
[e]motion XV-F 90-2-2 (TT3-30)	6.862,00	13.849,00	20.794,00	27.593,00
[e]motion XV-F 90-2 (TT3-30)	7.214,00	14.554,00	21.802,00	28.970,00
[e]motion XV-F 120-1 (TT3-30)	10.688,00	21.132,00	31.713,00	41.845,00
[e]motion XV-F 150-1-1 (TT3-30)	10.719,00	21.194,00	31.801,00	41.968,00
[e]motion XV-F 150-1 (TT3-30)	11.161,00	22.079,00	33.130,00	43.704,00



TIPO TYPE	PVP € 1 BOMBA	PVP € 2 BOMBAS	PVP € 3 BOMBAS	PVP € 4 BOMBAS
--------------	------------------	-------------------	-------------------	-------------------

SIGMA- EQUIPOS DE PRESIÓN



EP SIGMA 102 M	973,00	1.838,00	-	-
EP SIGMA 103 M	966,00	1.824,00	-	-
EP SIGMA 104 M	981,00	1.854,00	-	-
EP SIGMA 105 M	1.002,00	1.895,00	-	-
EP SIGMA 202 M	1.074,00	2.040,00	-	-
EP SIGMA 203 M	1.069,00	2.028,00	-	-
EP SIGMA 204 M	1.110,00	2.111,00	-	-
EP SIGMA 205 M	1.150,00	2.192,00	-	-
EP SIGMA 303 M	1.265,00	2.393,00	-	-
EP SIGMA 304 M	1.279,00	2.422,00	-	-
EP SIGMA 305 M	1.299,00	2.461,00	-	-
EP SIGMA 403 M	1.312,00	2.497,00	-	-
EP SIGMA 105	1.001,00	1.895,00	2.984,00	3.892,00
EP SIGMA 205	1.108,00	2.110,00	3.306,00	4.321,00
EP SIGMA 303	1.213,00	2.312,00	3.667,00	4.960,00
EP SIGMA 304	1.226,00	2.337,00	3.705,00	5.010,00
EP SIGMA 305	1.247,00	2.380,00	3.770,00	5.096,00
EP SIGMA 306	1.328,00	2.513,00	4.013,00	5.422,00
EP SIGMA 307	1.417,00	2.545,00	4.061,00	5.486,00
EP SIGMA 403	1.263,00	2.421,00	4.287,00	5.212,00
EP SIGMA 404	1.421,00	2.563,00	4.544,00	5.556,00



V-NOX- EQUIPOS DE PRESIÓN

EP V-NOX 303 M	1.313,00	2.490,00	-	-
EP V-NOX 304 M	1.328,00	2.519,00	-	-
EP V-NOX 305 M	1.348,00	2.560,00	-	-
EP V-NOX 403 M	1.262,00	2.409,00	3.813,00	5.154,00
EP V-NOX 303	1.275,00	2.435,00	3.851,00	5.205,00
EP V-NOX 304	1.297,00	2.479,00	3.918,00	5.293,00
EP V-NOX 305	1.378,00	2.642,00	4.163,00	5.623,00
EP V-NOX 306	1.395,00	2.675,00	4.213,00	5.689,00
EP V-NOX 307	1.532,00	2.949,00	4.624,00	6.249,00
EP V-NOX 308	1.560,00	2.997,00	4.691,00	6.336,00
EP V-NOX 309	1.649,00	3.175,00	4.971,00	6.694,00
EP V-NOX 403	1.310,00	2.515,00	4.427,00	5.398,00
EP V-NOX 404	1.396,00	2.688,00	4.687,00	5.747,00
EP V-NOX 405	1.540,00	2.976,00	5.120,00	6.337,00
EP V-NOX 406	1.561,00	3.017,00	5.181,00	6.418,00
EP V-NOX 407	1.652,00	3.200,00	5.467,00	6.786,00

TIPO
TYPE

PVP €
1 BOMBA

PVP €
2 BOMBAS

PVP €
3 BOMBAS

PVP €
4 BOMBAS

XV-F 5-45- EQUIPOS DE PRESIÓN



EP XV-F 5-8	1.553,00	2.991,00	4.683,00	6.082,00
EP XV-F 5-10	1.664,00	3.213,00	5.018,00	6.527,00
EP XV-F 5-14	1.811,00	3.507,00	5.460,00	7.116,00
EP XV-F 5-16	1.864,00	3.614,00	5.621,00	7.332,00
EP XV-F 5-20	2.178,00	4.232,00	6.543,00	8.570,00
EP XV-F 5-29	2.668,00	5.224,00	8.049,00	10.555,00
EP XV-F 5-36	3.649,00	6.942,00	10.169,00	13.905,00
EP XV-F 10-6	1.880,00	3.674,00	5.660,00	7.610,00
EP XV-F 10-9	2.218,00	4.349,00	6.673,00	8.973,00
EP XV-F 10-10	2.373,00	4.644,00	7.162,00	9.598,00
EP XV-F 10-12	2.494,00	4.773,00	7.351,00	9.848,00
EP XV-F 10-16	3.525,00	6.684,00	9.764,00	13.592,00
EP XV-F 10-22	4.142,00	7.929,00	11.635,00	16.149,00
EP XV-F 15-5	2.378,00	4.943,00	7.434,00	10.115,00
EP XV-F 15-7	3.359,00	6.535,00	9.540,00	13.095,00
EP XV-F 15-9	3.620,00	7.086,00	10.307,00	14.089,00
EP XV-F 15-14	4.933,00	9.612,00	14.187,00	19.171,00
EP XV-F 15-17	5.560,00	10.806,00	16.223,00	21.653,00
EP XV-F 20-5	3.435,00	6.673,00	9.729,00	13.372,00
EP XV-F 20-7	3.784,00	7.412,00	10.778,00	14.744,00
EP XV-F 20-10	4.782,00	9.453,00	13.845,00	18.508,00
EP XV-F 20-14	5.655,00	11.135,00	16.726,00	22.322,00
EP XV-F 20-17	6.208,00	12.237,00	18.182,00	24.548,00
EP XV-F 32-3	4.307,00	8.579,00	12.523,00	16.711,00
EP XV-F 32-4	4.664,00	9.332,00	13.594,00	18.111,00
EP XV-F 32-6	5.919,00	11.546,00	16.921,00	22.563,00
EP XV-F 32-8	6.776,00	13.186,00	19.728,00	26.288,00
EP XV-F 32-10	7.379,00	14.644,00	21.725,00	29.249,00
EP XV-F 32-12	8.549,00	16.943,00	25.315,00	34.118,00
EP XV-F 32-14	10.016,00	19.842,00	29.754,00	39.841,00
EP XV-F 45-2	4.763,00	9.252,00	13.648,00	18.356,00
EP XV-F 45-3	5.876,00	11.435,00	16.943,00	22.776,00
EP XV-F 45-4	6.457,00	12.523,00	18.922,00	25.396,00
EP XV-F 45-5	6.929,00	13.620,00	20.366,00	27.644,00
EP XV-F 45-6	8.027,00	15.774,00	23.758,00	32.224,00
EP XV-F 45-9-2	11.357,00	21.995,00	33.136,00	44.524,00
EP XV-F 45-10	12.026,00	23.646,00	35.426,00	47.184,00
EP XV-F 45-13-2	13.376,00	26.866,00	38.866,00	52.349,00

TIPO TYPE	PVP € 1 BOMBA	PVP € 2 BOMBAS	PVP € 3 BOMBAS	PVP € 4 BOMBAS
--------------	------------------	-------------------	-------------------	-------------------

XV-F 64-150- EQUIPOS DE PRESIÓN



EP XV-F 64-2	5.832,00	11.458,00	16.947,00	22.787,00
EP XV-F 64-3-1	6.560,00	12.841,00	19.367,00	25.997,00
EP XV-F 64-4-2	7.055,00	13.992,00	20.899,00	28.363,00
EP XV-F 64-4	7.900,00	15.631,00	23.513,00	31.904,00
EP XV-F 64-6-2	9.648,00	19.007,00	28.481,00	38.372,00
EP XV-F 64-7-1	12.483,00	24.641,00	36.751,00	48.997,00
EP XV-F 64-8-1	13.444,00	26.920,00	39.230,00	52.451,00
EP XV-F 90-2-2	6.043,00	12.004,00	17.744,00	23.624,00
EP XV-F 90-2	6.541,00	12.925,00	19.472,00	25.920,00
EP XV-F 90-3-2	7.078,00	14.161,00	21.085,00	28.456,00
EP XV-F 90-3	8.056,00	16.071,00	24.162,00	32.555,00
EP XV-F 90-4	9.628,00	19.103,00	28.625,00	38.317,00
EP XV-F 90-5	12.606,00	25.015,00	37.314,00	49.500,00
EP XV-F 90-6	13.560,00	27.281,00	39.750,00	52.926,00
EP XV-F 120-1	10.274,00	20.052,00	29.637,00	39.281,00
EP XV-F 120-2-1	12.303,00	24.194,00	35.983,00	48.017,00
EP XV-F 120-2	13.098,00	25.742,00	38.467,00	51.386,00
EP XV-F 120-3	15.646,00	30.693,00	45.969,00	61.158,00
EP XV-F 120-4-1	17.185,00	34.073,00	50.848,00	67.267,00
EP XV-F 120-5-1	18.878,00	37.802,00	55.502,00	73.651,00
EP XV-F 120-6-1	23.723,00	47.197,00	69.847,00	94.069,00
EP XV-F 120-7	31.373,00	61.295,00	92.397,00	122.340,00
EP XV-F 150-1-1	10.308,00	20.119,00	29.734,00	39.415,00
EP XV-F 150-1	10.901,00	21.229,00	31.732,00	42.068,00
EP XV-F 150-2-1	13.010,00	25.567,00	38.204,00	51.034,00
EP XV-F 150-3-2	15.770,00	30.940,00	46.338,00	61.652,00
EP XV-F 150-3	16.228,00	32.169,00	47.996,00	63.468,00
EP XV-F 150-4-1	17.934,00	35.915,00	52.671,00	69.877,00
EP XV-F 150-5-2	22.871,00	45.494,00	67.294,00	90.665,00
EP XV-F 150-6	30.641,00	59.830,00	90.200,00	119.411,00

SIGMA- EQUIPOS DE PRESIÓN CON VARIADOR ABB Y ALTERNANCIA

VARIO ALT SIGMA 303	2.837,00	4.372,00	6.114,00	7.969,00
VARIO ALT SIGMA 304	2.850,00	4.397,00	6.152,00	8.019,00
VARIO ALT SIGMA 305	2.869,00	4.440,00	6.216,00	8.105,00
VARIO ALT SIGMA 306	3.042,00	4.663,00	6.551,00	8.525,00
VARIO ALT SIGMA 307	3.131,00	4.695,00	6.598,00	8.590,00
VARIO ALT SIGMA 403	2.887,00	4.481,00	6.737,00	8.221,00
VARIO ALT SIGMA 404	3.137,00	4.713,00	7.081,00	8.660,00

TIPO TYPE	PVP € 1 BOMBA	PVP € 2 BOMBAS	PVP € 3 BOMBAS	PVP € 4 BOMBAS
--------------	------------------	-------------------	-------------------	-------------------

V-NOX- EQUIPOS DE PRESIÓN CON VARIADOR ABB Y ALTERNANCIA

VARIO ALT V-NOX 303	2.984,00	4.469,00	6.259,00	8.162,00
VARIO ALT V-NOX 304	2.997,00	4.494,00	6.297,00	8.213,00
VARIO ALT V-NOX 305	3.017,00	4.539,00	6.364,00	8.302,00
VARIO ALT V-NOX 306	3.191,00	4.794,00	6.701,00	8.726,00
VARIO ALT V-NOX 307	3.207,00	4.827,00	6.751,00	8.792,00
VARIO ALT V-NOX 308	3.440,00	5.240,00	7.305,00	9.485,00
VARIO ALT V-NOX 309	3.469,00	5.181,00	7.334,00	9.534,00
VARIO ALT V-NOX 310	3.788,00	5.608,00	7.856,00	10.140,00
VARIO ALT V-NOX 403	3.032,00	4.574,00	6.873,00	8.407,00
VARIO ALT V-NOX 404	3.210,00	4.839,00	7.225,00	8.850,00
VARIO ALT V-NOX 405	3.494,00	5.267,00	7.801,00	9.574,00
VARIO ALT V-NOX 406	3.512,00	5.307,00	7.862,00	9.655,00
VARIO ALT V-NOX 407	3.834,00	5.739,00	8.392,00	10.270,00



XV-F 5-45- EQUIPOS DE PRESIÓN CON VARIADOR ABB Y ALTERNANCIA

VARIO ALT XV-F 5-8	3.050,00	5.224,00	6.904,00	8.865,00
VARIO ALT XV-F 5-10	3.384,00	5.706,00	7.465,00	9.535,00
VARIO ALT XV-F 5-14	3.580,00	6.121,00	7.997,00	10.219,00
VARIO ALT XV-F 5-16	3.634,00	6.238,00	8.159,00	10.435,00
VARIO ALT XV-F 5-20	4.034,00	6.937,00	9.185,00	11.768,00
VARIO ALT XV-F 5-29	4.754,00	8.273,00	10.768,00	13.834,00
VARIO ALT XV-F 5-36	5.517,00	10.486,00	13.231,00	17.763,00

VARIO ALT XV-F 10-6	3.695,00	6.274,00	8.198,00	10.713,00
VARIO ALT XV-F 10-9	4.126,00	7.151,00	9.354,00	12.209,00
VARIO ALT XV-F 10-10	4.505,00	7.942,00	10.230,00	13.253,00
VARIO ALT XV-F 10-12	4.574,00	7.967,00	10.380,00	13.464,00
VARIO ALT XV-F 10-16	5.393,00	10.209,00	12.993,00	16.376,00
VARIO ALT XV-F 10-22	6.950,00	12.932,00	16.212,00	21.304,00

VARIO ALT XV-F 15-5	4.552,00	8.264,00	10.501,00	13.770,00
VARIO ALT XV-F 15-7	5.289,00	10.225,00	12.838,00	17.174,00
VARIO ALT XV-F 15-9	6.023,00	11.252,00	14.237,00	18.535,00
VARIO ALT XV-F 15-14	7.650,00	14.589,00	18.535,00	24.075,00
VARIO ALT XV-F 15-17	8.898,00	17.018,00	21.849,00	27.211,00

VARIO ALT XV-F 20-5	5.559,00	9.860,00	13.280,00	17.764,00
VARIO ALT XV-F 20-7	6.372,00	11.148,00	15.053,00	19.574,00
VARIO ALT XV-F 20-10	7.707,00	13.691,00	18.707,00	23.968,00
VARIO ALT XV-F 20-14	9.333,00	16.517,00	22.785,00	28.307,00
VARIO ALT XV-F 20-17	10.503,00	18.145,00	24.878,00	31.034,00

VARIO ALT XV-F 32-3	6.430,00	11.766,00	16.074,00	21.103,00
VARIO ALT XV-F 32-4	7.298,00	13.068,00	17.869,00	22.941,00
VARIO ALT XV-F 32-6	8.900,00	15.784,00	21.783,00	28.023,00
VARIO ALT XV-F 32-8	10.371,00	18.567,00	25.966,00	32.452,00
VARIO ALT XV-F 32-10	11.674,00	20.553,00	28.422,00	35.735,00



TIPO TYPE	PVP € 1 BOMBA	PVP € 2 BOMBAS	PVP € 3 BOMBAS	PVP € 4 BOMBAS
--------------	------------------	-------------------	-------------------	-------------------

XV-F 5-45- MODELO EQUIPO BOOSTER TYPE: EQUIPOS DE PRESIÓN CON VARIADOR ABBY ALTERNANCIA



VARIO ALT XV-F 32-12	13.558,00	24.008,00	33.181,00	44.395,00
VARIO ALT XV-F 32-14	15.624,00	27.279,00	38.005,00	50.257,00
VARIO ALT XV-F 45-2	7.490,00	12.988,00	17.923,00	23.186,00
VARIO ALT XV-F 45-3	8.993,00	15.788,00	21.847,00	28.278,00
VARIO ALT XV-F 45-4	10.197,00	18.020,00	25.202,00	31.602,00
VARIO ALT XV-F 45-5	11.370,00	19.528,00	27.241,00	34.309,00
VARIO ALT XV-F 45-6	13.265,00	22.839,00	31.803,00	42.679,00
VARIO ALT XV-F 45-9-2	16.957,00	29.432,00	41.387,00	54.939,00
VARIO ALT XV-F 45-10	18.476,00	32.240,00	44.877,00	59.174,00
VARIO ALT XV-F 45-13-2	20.983,00	37.208,00	51.962,00	65.888,00

XV-F 64-150- EQUIPOS DE PRESIÓN CON VARIADOR ABB Y ALTERNANCIA

VARIO ALT XV-F 64-2	8.951,00	15.811,00	21.851,00	28.289,00
VARIO ALT XV-F 64-3-1	10.346,00	18.337,00	25.647,00	32.202,00
VARIO ALT XV-F 64-4-2	11.496,00	20.015,00	27.816,00	35.070,00
VARIO ALT XV-F 64-4	13.055,00	22.696,00	31.559,00	42.359,00
VARIO ALT XV-F 64-6-2	15.248,00	26.444,00	36.910,00	48.966,00
VARIO ALT XV-F 64-7-1	18.932,00	33.235,00	46.202,00	60.986,00
VARIO ALT XV-F 64-8-1	21.273,00	37.262,00	52.326,00	65.990,00
VARIO ALT XV-F 90-2-2	9.163,00	16.357,00	22.648,00	29.135,00
VARIO ALT XV-F 90-2	10.327,00	18.421,00	25.752,00	32.126,00
VARIO ALT XV-F 90-3-2	11.565,00	20.184,00	28.002,00	35.163,00
VARIO ALT XV-F 90-3	13.211,00	23.255,00	32.249,00	43.053,00
VARIO ALT XV-F 90-4	15.232,00	26.534,00	37.054,00	48.912,00
VARIO ALT XV-F 90-5	19.055,00	33.603,00	46.765,00	61.490,00
VARIO ALT XV-F 90-6	21.389,00	37.616,00	52.845,00	66.465,00
VARIO ALT XV-F 120-1	13.253,00	24.313,00	34.416,00	44.636,00
VARIO ALT XV-F 120-2-1	16.650,00	30.096,00	42.724,00	54.514,00
VARIO ALT XV-F 120-2	18.159,00	32.801,00	46.378,00	61.674,00
VARIO ALT XV-F 120-3	21.281,00	38.104,00	54.279,00	71.620,00
VARIO ALT XV-F 120-4-1	23.669,00	42.626,00	60.328,00	79.258,00
VARIO ALT XV-F 120-5-1	26.640,00	48.003,00	68.672,00	87.236,00
VARIO ALT XV-F 120-6-1	31.144,00	58.689,00	84.434,00	108.468,00
VARIO ALT XV-F 120-7	40.025,00	74.339,00	107.431,00	138.095,00
VARIO ALT XV-F 150-1-1	13.286,00	24.380,00	34.516,00	44.770,00
VARIO ALT XV-F 150-1	14.548,00	26.619,00	37.866,00	48.105,00
VARIO ALT XV-F 150-2-1	18.071,00	32.626,00	46.115,00	61.322,00
VARIO ALT XV-F 150-3-2	21.404,00	38.351,00	54.649,00	72.113,00
VARIO ALT XV-F 150-3	22.712,00	40.722,00	57.477,00	75.459,00
VARIO ALT XV-F 150-4-1	25.752,00	46.116,00	65.842,00	83.462,00
VARIO ALT XV-F 150-5-2	30.292,00	56.987,00	82.059,00	105.243,00
VARIO ALT XV-F 150-6	39.293,00	72.875,00	105.234,00	135.167,00

EQUIPOS CONTRAINCENDIOS UNE 23500:2018

U.E. - 1 Bomba Principal Eléctrica + Jockey - Equipamiento sencillo

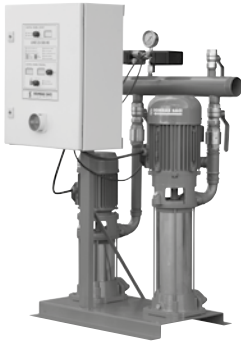

MODELO MODEL	P.V.P.	MODELO MODEL	P.V.P.
X.E / 406 (UNE 2012 - ANEXO C)	3.081,00	U.E / 420 A	5.430,00
X.E / 407 (UNE 2012 - ANEXO C)	3.402,00	U.E / 425 B	6.285,00
X.E / 15-7 (UNE 2012 - ANEXO C)	4.992,00	U.E / 425 A	7.642,00
U.E / 404	3.153,00	U.E / 520 C	6.206,00
U.E / 405	3.309,00	U.E / 520 B	6.371,00
U.E / 406	3.419,00	U.E / 520 A	7.668,00
U.E / 407	3.720,00	U.E / 525 C	7.875,00
U.E / 15-7	5.454,00	U.E / 525 B	8.479,00
U.E / 15-9	5.820,00	U.E / 525 A	8.987,00
U.E / 420 B	5.191,00		

U.E.E. - 2 Bombas Principales Eléctricas + Jockey - Equipamiento sencillo

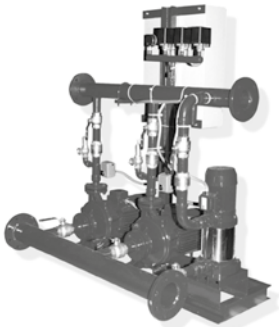

MODELO MODEL	P.V.P.	MODELO MODEL	P.V.P.
U.E.E / 404	5.779,00	U.E.E / 425 B	11.165,00
U.E.E / 405	6.091,00	U.E.E / 425 A	13.737,00
U.E.E / 406	6.221,00	U.E.E / 520 C	11.232,00
U.E.E / 407	6.533,00	U.E.E / 520 B	11.553,00
U.E.E / 15-7	9.263,00	U.E.E / 520 A	13.874,00
U.E.E / 15-9	9.890,00	U.E.E / 525 C	14.191,00
U.E.E / 420 B	9.359,00	U.E.E / 525 B	15.381,00
U.E.E / 420 A	9.566,00	U.E.E / 525 A	16.262,00

U.D. - 1 Bomba Principal Diésel + Jockey - Equipamiento sencillo

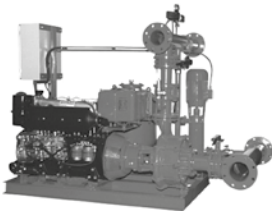

MODELO MODEL	P.V.P.	MODELO MODEL	P.V.P.
U.D / 404	8.037,00	U.D / 420 A	14.017,00
U.D / 405	8.037,00	U.D / 425 B	14.076,00
U.D / 406	8.130,00	U.D / 520 C	14.124,00
U.D / 407	8.329,00	U.D / 520 B	14.124,00
U.D / 15-7*	13.228,00	U.D / 520 A	14.124,00
U.D / 420 B	14.017,00		

*Altura máxima de 80 mca / Maximum pressure 80 wcm

U.E.D - PPAL Eléctrica + PPAL Diésel + Jockey - Equipamiento sencillo

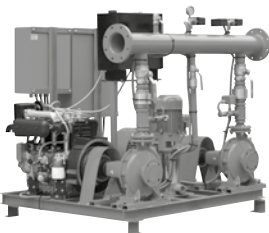

MODELO MODEL	P.V.P.	MODELO MODEL	P.V.P.
U.E.D / 404	10.036,00	U.E.D / 420 A	17.695,00
U.E.D / 405	10.192,00	U.E.D / 425 B	18.909,00
U.E.D / 406	10.304,00	U.E.D / 520 C	18.933,00
U.E.D / 407	10.560,00	U.E.D / 520 B	19.070,00
U.E.D / 15-7*	16.680,00	U.E.D / 520 A	20.321,00
U.E.D / 420 B	17.608,00		

*Altura máxima de 80 mca / Maximum pressure 80 wcm

**PARA OTRAS NORMATIVAS CONSULTE
CON NUESTRO DEPARTAMENTO COMERCIAL**

EQUIPOS CONTRAINCENDIOS UNE 23500:2018

U.E. - 1 Bomba Principal Eléctrica + Jockey - Equipamiento Superior



MODELO MODEL	P.V.P.	MODELO MODEL	P.V.P.
U.E / 316 S 17 /7.5	8.079,00	U.E / 625 S 24 /50	13.554,00
U.E / 320 S 20 /10	8.272,00	U.E / 625 S 25 /50	13.554,00
U.E / 320 S 22 /15	9.335,00	U.E / 625 S 26 /60	14.257,00
U.E / 325 S 23 /25	10.325,00	U.E / 631 S 27 /75	16.544,00
U.E / 325 S 25 /30	11.458,00	U.E / 631 S 28 /100	19.596,00
U.E / 325 S 26 /30	11.478,00	U.E / 820 S 20 /50	13.468,00
U.E / 425 S 24 /25	10.326,00	U.E / 820 S 21 /60	13.954,00
U.E / 420 S 22 /20	9.881,00	U.E / 825 S 23 /75	16.306,00
U.E / 425 S 23 /25	10.346,00	U.E / 825 S 24 /100	19.111,00
U.E / 425 S 25 /30	11.515,00	U.E / 825 S 25 /100	19.493,00
U.E / 425 S 26 /30	11.739,00	U.E / 825 S 27 /125	20.392,00
U.E / 525 S 22 /30	11.776,00	U.E / 831 S 28 /125	20.881,00
U.E / 525 S 23 /30	11.776,00	U.E / 831 S 29 /150	26.103,00
U.E / 525 S 24 /40	12.630,00	U.E / 1020 S 21 /75	16.396,00
U.E / 525 S 25 /40	12.630,00	U.E / 1020 S 22 /100	19.358,00
U.E / 525 S 26 /50	13.217,00	U.E / 1025 S 24 /100	19.839,00
U.E / 652 S 20 /30	11.673,00	U.E / 1025 S 25 /125	20.872,00
U.E / 652 S 21 /40	12.476,00	U.E / 1025 S 26 /150	26.094,00
U.E / 652 S 22 /40	12.501,00		

U.E.E. - 2 Principales Eléctricas + Jockey - Equipamiento superior

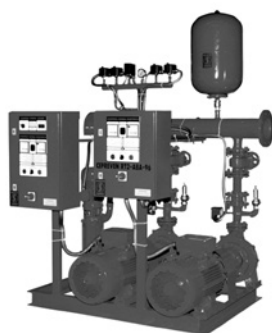

MODELO MODEL	P.V.P.	MODELO MODEL	P.V.P.
U.E.E / 316 S 17 /7.5	14.554,00	U.E.E / 625 S 24 /50	25.330,00
U.E.E / 320 S 20 /10	15.032,00	U.E.E / 625 S 25 /50	25.330,00
U.E.E / 320 S 22 /15	17.070,00	U.E.E / 625 S 26 /60	26.477,00
U.E.E / 325 S 23 /25	19.003,00	U.E.E / 631 S 27 /75	31.048,00
U.E.E / 325 S 25 /30	21.060,00	U.E.E / 631 S 28 /100	36.902,00
U.E.E / 325 S 26 /30	21.079,00	U.E.E / 820 S 20 /50	25.068,00
U.E.E / 425 S 24 /25	19.020,00	U.E.E / 820 S 21 /60	25.998,00
U.E.E / 420 S 22 /20	18.136,00	U.E.E / 825 S 23 /75	30.719,00
U.E.E / 425 S 23 /25	19.050,00	U.E.E / 825 S 24 /100	36.301,00
U.E.E / 425 S 25 /30	21.347,00	U.E.E / 825 S 25 /100	36.709,00
U.E.E / 425 S 26 /30	21.572,00	U.E.E / 825 S 27 /125	38.475,00
U.E.E / 525 S 22 /30	21.818,00	U.E.E / 831 S 28 /125	39.454,00
U.E.E / 525 S 23 /30	21.818,00	U.E.E / 831 S 29 /150	49.808,00
U.E.E / 525 S 24 /40	23.505,00	U.E.E / 1020 S 21 /75	30.862,00
U.E.E / 525 S 25 /40	23.505,00	U.E.E / 1020 S 22 /100	36.625,00
U.E.E / 525 S 26 /50	24.415,00	U.E.E / 1025 S 24 /100	37.585,00
U.E.E / 652 S 20 /30	21.624,00	U.E.E / 1025 S 25 /125	39.485,00
U.E.E / 652 S 21 /40	23.231,00	U.E.E / 1025 S 26 /150	49.844,00
U.E.E / 652 S 22 /40	23.261,00		

**PARA OTRAS NORMATIVAS CONSULTE
CON NUESTRO DEPARTAMENTO COMERCIAL**

EQUIPOS CONTRAINCENDIOS UNE 23500:2018

U.D. - 1 Bomba Principal Diésel + Jockey - Equipamiento superior

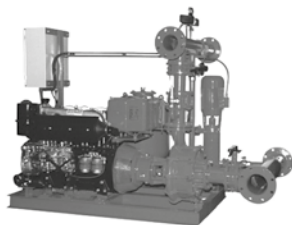

MODELO MODEL	P.V.P.	MODELO MODEL	P.V.P.
U.D / 316 S 17 / 7.5	13.142,00	U.D / 625 S 24 / 50	21.867,00
U.D / 320 S 20 / 10	13.279,00	U.D / 625 S 25 / 50	21.867,00
U.D / 320 S 22 / 15	17.435,00	U.D / 625 S 26 / 60	24.368,00
U.D / 325 S 23 / 25	18.970,00	U.D / 631 S 27 / 75	25.706,00
U.D / 325 S 25 / 30	20.055,00	U.D / 631 S 28 / 100	28.559,00
U.D / 325 S 26 / 30	20.074,00	U.D / 820 S 20 / 50	21.776,00
U.D / 425 S 24 / 25	18.982,00	U.D / 820 S 21 / 60	24.055,00
U.D / 420 S 22 / 20	17.955,00	U.D / 825 S 23 / 75	25.457,00
U.D / 425 S 23 / 25	19.003,00	U.D / 825 S 24 / 100	28.070,00
U.D / 425 S 25 / 30	19.890,00	U.D / 825 S 25 / 100	28.472,00
U.D / 425 S 26 / 30	20.113,00	U.D / 825 S 27 / 125	30.442,00
U.D / 525 S 22 / 30	20.150,00	U.D / 831 S 28 / 125	30.947,00
U.D / 525 S 23 / 30	20.171,00	U.D / 831 S 29 / 150	38.308,00
U.D / 525 S 24 / 40	20.388,00	U.D / 1020 S 21 / 75	25.552,00
U.D / 525 S 25 / 40	20.388,00	U.D / 1020 S 22 / 100	28.323,00
U.D / 525 S 26 / 50	21.156,00	U.D / 1025 S 24 / 100	28.835,00
U.D / 652 S 20 / 30	20.555,00	U.D / 1025 S 25 / 125	30.936,00
U.D / 652 S 21 / 40	20.556,00	U.D / 1025 S 26 / 150	38.257,00
U.D / 652 S 22 / 40	20.582,00		

U.E.D - PPAL Eléctrica + PPAL Diésel + Jockey - Equipamiento superior

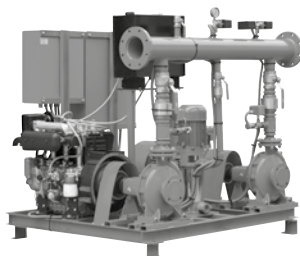

MODELO MODEL	P.V.P.	MODELO MODEL	P.V.P.
U.E.D / 316 S 17 / 7.5	18.985,00	U.E.D / 625 S 24 / 50	33.358,00
U.E.D / 320 S 20 / 10	19.360,00	U.E.D / 625 S 25 / 50	33.358,00
U.E.D / 320 S 22 / 15	24.498,00	U.E.D / 625 S 26 / 60	36.359,00
U.E.D / 325 S 23 / 25	26.998,00	U.E.D / 631 S 27 / 75	40.030,00
U.E.D / 325 S 25 / 30	28.992,00	U.E.D / 631 S 28 / 100	45.660,00
U.E.D / 325 S 26 / 30	29.010,00	U.E.D / 820 S 20 / 50	33.087,00
U.E.D / 425 S 24 / 25	27.023,00	U.E.D / 820 S 21 / 60	35.866,00
U.E.D / 420 S 22 / 20	25.539,00	U.E.D / 825 S 23 / 75	39.691,00
U.E.D / 425 S 23 / 25	27.052,00	U.E.D / 825 S 24 / 100	45.040,00
U.E.D / 425 S 25 / 30	29.246,00	U.E.D / 825 S 25 / 100	45.461,00
U.E.D / 425 S 26 / 30	29.471,00	U.E.D / 825 S 27 / 125	48.339,00
U.E.D / 525 S 22 / 30	29.716,00	U.E.D / 831 S 28 / 125	49.348,00
U.E.D / 525 S 23 / 30	29.716,00	U.E.D / 831 S 29 / 150	62.021,00
U.E.D / 525 S 24 / 40	30.585,00	U.E.D / 1020 S 21 / 75	39.838,00
U.E.D / 525 S 25 / 40	30.585,00	U.E.D / 1020 S 22 / 100	45.374,00
U.E.D / 525 S 26 / 50	31.736,00	U.E.D / 1025 S 24 / 100	46.363,00
U.E.D / 652 S 20 / 30	30.118,00	U.E.D / 1025 S 25 / 125	49.380,00
U.E.D / 652 S 21 / 40	30.955,00	U.E.D / 1025 S 26 / 150	62.058,00
U.E.D / 652 S 22 / 40	30.987,00		

**PARA OTRAS NORMATIVAS CONSULTE
CON NUESTRO DEPARTAMENTO COMERCIAL**

EQUIPOS CONTRA INCENDIOS EN-12845

N.E. - 1 Bomba Principal Eléctrica + Jockey



MODELO MODEL	P.V.P.	MODELO MODEL	P.V.P.
N.E / 316 S 17 / 7.5	8.046,00	N.E / 625 S 24 / 50	13.294,00
N.E / 320 S 20 / 10	8.218,00	N.E / 625 S 25 / 50	13.294,00
N.E / 320 S 22 / 15	8.905,00	N.E / 625 S 26 / 60	13.997,00
N.E / 325 S 23 / 25	10.110,00	N.E / 631 S 27 / 75	16.284,00
N.E / 325 S 25 / 30	11.006,00	N.E / 631 S 28 / 100	19.334,00
N.E / 325 S 26 / 30	11.026,00	N.E / 820 S 20 / 50	13.175,00
N.E / 425 S 24 / 25	10.110,00	N.E / 820 S 21 / 60	13.662,00
N.E / 420 S 22 / 20	9.286,00	N.E / 825 S 23 / 75	16.014,00
N.E / 425 S 23 / 25	10.134,00	N.E / 825 S 24 / 100	18.817,00
N.E / 425 S 25 / 30	11.069,00	N.E / 825 S 25 / 100	19.200,00
N.E / 425 S 26 / 30	11.302,00	N.E / 825 S 27 / 125	20.099,00
N.E / 525 S 22 / 30	11.282,00	N.E / 831 S 28 / 125	20.589,00
N.E / 525 S 23 / 30	11.282,00	N.E / 831 S 29 / 150	25.809,00
N.E / 525 S 24 / 40	12.188,00	N.E / 1020 S 21 / 75	16.019,00
N.E / 525 S 25 / 40	12.188,00	N.E / 1020 S 22 / 100	18.981,00
N.E / 525 S 26 / 50	12.741,00	N.E / 1025 S 24 / 100	19.461,00
N.E / 652 S 20 / 30	11.415,00	N.E / 1025 S 25 / 125	20.493,00
N.E / 652 S 21 / 40	12.219,00	N.E / 1025 S 26 / 150	25.716,00
N.E / 652 S 22 / 40	12.240,00		

N.E.E. - 2 Principales Eléctricas + Jockey

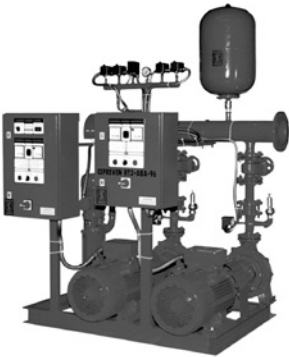

MODELO MODEL	P.V.P.	MODELO MODEL	P.V.P.
N.E.E / 316 S 17 / 7.5	14.522,00	N.E.E / 625 S 24 / 50	24.835,00
N.E.E / 320 S 20 / 10	14.962,00	N.E.E / 625 S 25 / 50	24.835,00
N.E.E / 320 S 22 / 15	16.282,00	N.E.E / 625 S 26 / 60	25.981,00
N.E.E / 325 S 23 / 25	18.664,00	N.E.E / 631 S 27 / 75	30.552,00
N.E.E / 325 S 25 / 30	20.239,00	N.E.E / 631 S 28 / 100	36.406,00
N.E.E / 325 S 26 / 30	20.260,00	N.E.E / 820 S 20 / 50	24.507,00
N.E.E / 425 S 24 / 25	18.665,00	N.E.E / 820 S 21 / 60	25.437,00
N.E.E / 420 S 22 / 20	17.022,00	N.E.E / 825 S 23 / 75	30.157,00
N.E.E / 425 S 23 / 25	18.697,00	N.E.E / 825 S 24 / 100	35.740,00
N.E.E / 425 S 25 / 30	20.530,00	N.E.E / 825 S 25 / 100	36.148,00
N.E.E / 425 S 26 / 30	20.763,00	N.E.E / 825 S 27 / 125	37.914,00
N.E.E / 525 S 22 / 30	20.869,00	N.E.E / 831 S 28 / 125	38.893,00
N.E.E / 525 S 23 / 30	20.869,00	N.E.E / 831 S 29 / 150	49.247,00
N.E.E / 525 S 24 / 40	22.662,00	N.E.E / 1020 S 21 / 75	30.132,00
N.E.E / 525 S 25 / 40	22.662,00	N.E.E / 1020 S 22 / 100	35.895,00
N.E.E / 525 S 26 / 50	23.496,00	N.E.E / 1025 S 24 / 100	36.855,00
N.E.E / 652 S 20 / 30	21.134,00	N.E.E / 1025 S 25 / 125	38.755,00
N.E.E / 652 S 21 / 40	22.741,00	N.E.E / 1025 S 26 / 150	49.114,00
N.E.E / 652 S 22 / 40	22.766,00		

**PARA OTRAS NORMATIVAS CONSULTE
CON NUESTRO DEPARTAMENTO COMERCIAL**

EQUIPOS CONTRAINCENDIOS EN-12845

N.D. - 1 Bomba Principal Diésel + Jockey

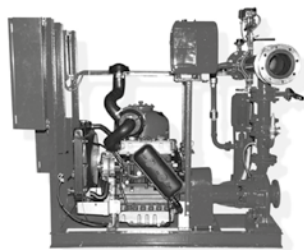

MODELO MODEL	P.V.P.	MODELO MODEL	P.V.P.
N.D / 316 S 17 / 7.5	12.714,00	N.D / 625 S 24 / 50	21.355,00
N.D / 320 S 20 / 10	12.851,00	N.D / 625 S 25 / 50	21.355,00
N.D / 320 S 22 / 15	17.008,00	N.D / 625 S 26 / 60	23.856,00
N.D / 325 S 23 / 25	18.500,00	N.D / 631 S 27 / 75	25.194,00
N.D / 325 S 25 / 30	19.585,00	N.D / 631 S 28 / 100	28.047,00
N.D / 325 S 26 / 30	19.603,00	N.D / 820 S 20 / 50	21.232,00
N.D / 425 S 24 / 25	18.512,00	N.D / 820 S 21 / 60	23.509,00
N.D / 420 S 22 / 20	17.488,00	N.D / 825 S 23 / 75	24.912,00
N.D / 425 S 23 / 25	18.535,00	N.D / 825 S 24 / 100	27.525,00
N.D / 425 S 25 / 30	19.419,00	N.D / 825 S 25 / 100	27.927,00
N.D / 425 S 26 / 30	19.643,00	N.D / 825 S 27 / 125	29.898,00
N.D / 525 S 22 / 30	19.659,00	N.D / 831 S 28 / 125	30.402,00
N.D / 525 S 23 / 30	19.679,00	N.D / 831 S 29 / 150	37.763,00
N.D / 525 S 24 / 40	19.894,00	N.D / 1020 S 21 / 75	24.919,00
N.D / 525 S 25 / 40	19.894,00	N.D / 1020 S 22 / 100	27.692,00
N.D / 525 S 26 / 50	20.661,00	N.D / 1025 S 24 / 100	28.204,00
N.D / 652 S 20 / 30	20.046,00	N.D / 1025 S 25 / 125	30.304,00
N.D / 652 S 21 / 40	20.047,00	N.D / 1025 S 26 / 150	37.624,00
N.D / 652 S 22 / 40	20.070,00		

N.E.D - PPAL Eléctrica + PPAL Diésel + Jockey

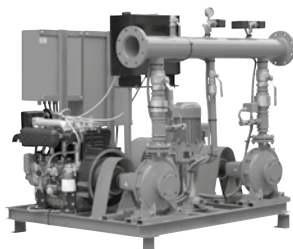

MODELO MODEL	P.V.P.	MODELO MODEL	P.V.P.
N.E.D / 316 S 17 / 7.5	18.461,00	N.E.D / 625 S 24 / 50	32.677,00
N.E.D / 320 S 20 / 10	18.835,00	N.E.D / 625 S 25 / 50	32.677,00
N.E.D / 320 S 22 / 15	23.974,00	N.E.D / 625 S 26 / 60	35.680,00
N.E.D / 325 S 23 / 25	26.176,00	N.E.D / 631 S 27 / 75	39.351,00
N.E.D / 325 S 25 / 30	27.640,00	N.E.D / 631 S 28 / 100	44.981,00
N.E.D / 325 S 26 / 30	27.718,00	N.E.D / 820 S 20 / 50	32.339,00
N.E.D / 425 S 24 / 25	26.365,00	N.E.D / 820 S 21 / 60	35.117,00
N.E.D / 420 S 22 / 20	24.947,00	N.E.D / 825 S 23 / 75	38.942,00
N.E.D / 425 S 23 / 25	26.461,00	N.E.D / 825 S 24 / 100	42.380,00
N.E.D / 425 S 25 / 30	28.649,00	N.E.D / 825 S 25 / 100	44.713,00
N.E.D / 425 S 26 / 30	28.872,00	N.E.D / 825 S 27 / 125	47.592,00
N.E.D / 525 S 22 / 30	29.075,00	N.E.D / 831 S 28 / 125	48.600,00
N.E.D / 525 S 23 / 30	29.075,00	N.E.D / 831 S 29 / 150	61.274,00
N.E.D / 525 S 24 / 40	29.938,00	N.E.D / 1020 S 21 / 75	38.915,00
N.E.D / 525 S 25 / 40	29.938,00	N.E.D / 1020 S 22 / 100	44.452,00
N.E.D / 525 S 26 / 50	30.926,00	N.E.D / 1025 S 24 / 100	45.440,00
N.E.D / 652 S 20 / 30	29.444,00	N.E.D / 1025 S 25 / 125	48.458,00
N.E.D / 652 S 21 / 40	30.282,00	N.E.D / 1025 S 26 / 150	61.137,00
N.E.D / 652 S 22 / 40	30.306,00		

**PARA OTRAS NORMATIVAS CONSULTE
CON NUESTRO DEPARTAMENTO COMERCIAL**

COLECTORES DE PRUEBAS CON CAUDALÍMETRO

COLECTORES DE PRUEBAS MODELO ECO F-300



MODELO COLECTOR	P.V.P.
COLECTOR PRUEBAS ECO F-300 - DN 50	398,00
COLECTOR PRUEBAS ECO F-300 - DN 65	437,00
COLECTOR PRUEBAS ECO F-300 - DN 80	602,00
COLECTOR PRUEBAS ECO F-300 - DN 100	710,00
COLECTOR PRUEBAS ECO F-300 - DN 150	1.280,00
COLECTOR PRUEBAS ECO F-300 - DN 200	1.925,00

CAUDALÍMETROS SUELTOS

CAUDALÍMETROS SUELTOS ECO F-300



MODELO	P.V.P.
CAUDALIMETRO 1-1/2' -50 MM (3-21 M3/H) F30050M	318,00
CAUDALIMETRO 2' - 63 MM (6-28 M3/H) F30063M	337,00
CAUDALIMETRO 2-1/2' -75 MM (9-42 M3/H) F30075M	361,00
CAUDALIMETRO 3' -90 MM (12-51 M3/H) F30090M	378,00
CAUDALIMETRO 4' -110 MM (36-108 M3/H) F30110M	395,00
CAUDALIMETRO 6' -160 MM (54-192 M3/H) F30160M	603,00
CAUDALIMETRO 8' -200 MM (90-306 M3/H) F30200M	668,00

	1 1/2"	2"	2 1/2"	3"	4"	6"	8"
CAUDAL mínimo	3	6	9	12	36	54	90
CAUDAL máximo	21	28	42	51	108	192	306

	TIPO TYPE	CV HP	PVP € BOMBA/Pump
--	--------------	----------	---------------------

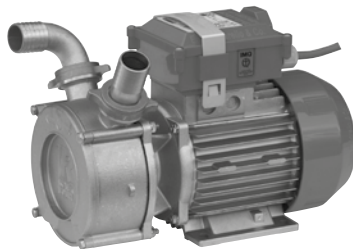

ROVER-BE-MARINA AUTOASPIRANTES USOS VARIOS

ROVER 20 M CE		171,00
BE 20 M IP 55		226,00
BE 25 M		293,00
ROVER 30 M CE		329,00
BE 30 T		419,00
ROVER 40 M CE		410,00
BE 40 T		495,00
MARINA 12V		470,00
MARINA 24V		470,00
DRILL 20		97,00
KIT BE-25 M CONTADOR		938,00

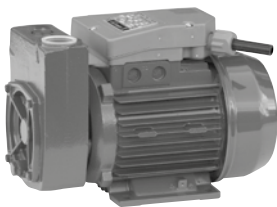

MD- AUTOASPIRANTES PARA GAS-OIL

PEDROLLO CKRM 90 IPX5	1	CONSULTAR
+ VITON S1 (EX MD-75 M)		
KIT (ASPIRACIÓN-IMPULSIÓN) Ø20		107,00
PISTOLA AUTOMÁTICA 60 lts/min		167,00
CONTADOR GAS-OIL		256,00

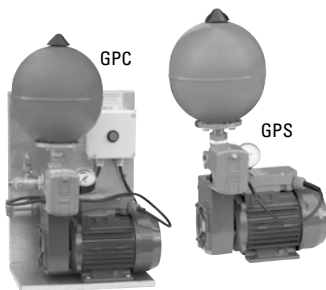

GPS/GPC- GRUPOS DE PRESIÓN PARA GAS-OIL

GPS (SIMPLE)	0,8	708,00
GPC (COMPACTO)	0,8	1.022,00



BOMBAS DE ARRASTRE MAGNETICOY VACIADO DE BIDONES

HCM 75	536,00
HCM 100	953,00
HCM 130	1.172,00

TIPO
TYPE

PVP €
Monof/Single ph



EVOSTA- CIRCULADORAS DOMESTICAS

BOMBA EVOSTA-2 40-70/130 M (1/2")	279,00
BOMBA EVOSTA-2 40-70/130 M	279,00
BOMBA EVOSTA-2 40-70/180 M	279,00



BOMBA EVOSTA-3 40/130 M	311,00
BOMBA EVOSTA-3 40/180 M	311,00
BOMBA EVOSTA-3 60/130 M	350,00
BOMBA EVOSTA-3 60/180 M	350,00
BOMBA EVOSTA-3 60/180 XM	357,00
BOMBA EVOSTA-3 80/130 M	422,00
BOMBA EVOSTA-3 80/180 M	422,00
BOMBA EVOSTA-3 80/180 XM	427,00

EVOPLUS SMALL- CIRCULADORAS PEQUEÑAS INST.



EVOPLUS SMALL 60/180 XM	842,00
EVOPLUS SMALL 80/180 XM	937,00
EVOPLUS SMALL 110/180 XM	1.040,00

EVOPLUS SMALL B 40/220.32 M	801,00
EVOPLUS SMALL B 60/220.32 M	884,00
EVOPLUS SMALL B 80/220.32 M	983,00
EVOPLUS SMALL B 110/220.32 M	1.081,00
EVOPLUS SMALL B 120/220.32 M	1.721,00



EVOPLUS SMALL D 40/220.32 M (DOBLE)	1.880,00
EVOPLUS SMALL D 60/220.32 M (DOBLE)	2.040,00
EVOPLUS SMALL D 80/220.32 M (DOBLE)	2.233,00
EVOPLUS SMALL D 110/220.32 M (DOBLE)	2.435,00
EVOPLUS SMALL D 120/220.32 M (DOBLE)	3.101,00

EVOPLUS SMALL B 60/250.40 M	963,00
EVOPLUS SMALL B 80/250.40 M	1.062,00
EVOPLUS SMALL B 110/250.40 M	1.163,00

EVOPLUS SMALL D 60/250.40 M (DOBLE)	2.176,00
EVOPLUS SMALL D 80/250.40 M (DOBLE)	2.367,00
EVOPLUS SMALL D 110/250.40 M (DOBLE)	2.568,00

EVOPLUS B CIRCULADORAS SIMPLES INST. COLECTIVAS



EVOPLUS B 40/220.40 M	1.642,00
EVOPLUS B 60/220.40 M	1.703,00
EVOPLUS B 80/220.40 M	1.761,00
EVOPLUS B 100/220.40 M	1.878,00
EVOPLUS B 120/250.40 M	2.019,00
EVOPLUS B 150/250.40 M	2.506,00
EVOPLUS B 180/250.40 M	2.898,00

EVOPLUS B 40/240.50 M	1.840,00
EVOPLUS B 60/240.50 M	2.155,00
EVOPLUS B 80/240.50 M	2.332,00

TIPO
TYPE

PVP €
Monof/Single ph

EVOPLUS B CIRCULADORAS SIMPLES INST. COLECTIVAS



EVOPLUS B 100/280.50 M	2.506,00
EVOPLUS B 120/280.50 M	2.701,00
EVOPLUS B 150/280.50 M	2.976,00
EVOPLUS B 180/280.50 M	3.249,00
EVOPLUS B 40/340.65 M	2.312,00
EVOPLUS B 60/340.65 M	2.662,00
EVOPLUS B 80/340.65 M	2.840,00
EVOPLUS B 100/340.65 M	2.976,00
EVOPLUS B 120/340.65 M	3.249,00
EVOPLUS B 150/340.65 M	3.680,00
EVOPLUS B 40/360.80 M	2.779,00
EVOPLUS B 60/360.80 M	3.014,00
EVOPLUS B 80/360.80 M	3.249,00
EVOPLUS B 100/360.80 M	3.600,00
EVOPLUS B 120/360.80 M	3.995,00
EVOPLUS B 40/450.100 M	3.249,00
EVOPLUS B 60/450.100 M	3.525,00
EVOPLUS B 80/450.100 M	3.838,00
EVOPLUS B 100/450.100 M	4.227,00
EVOPLUS B 120/450.100 M	4.736,00

EVOPLUS D CIRCULADORAS DOBLES INST. COLECTIVAS



EVOPLUS D 40/220.40 M	3.021,00
EVOPLUS D 60/220.40 M	3.080,00
EVOPLUS D 80/220.40 M	3.128,00
EVOPLUS D 100/220.40 M	3.344,00
EVOPLUS D 120/250.40 M	3.716,00
EVOPLUS D 150/250.40 M	4.510,00
EVOPLUS D 180/250.40 M	5.174,00
EVOPLUS D 40/240.50 M	3.309,00
EVOPLUS D 60/240.50 M	3.874,00
EVOPLUS D 80/240.50 M	4.233,00
EVOPLUS D 100/280.50 M	4.510,00
EVOPLUS D 120/280.50 M	4.862,00
EVOPLUS D 150/280.50 M	5.589,00
EVOPLUS D 180/280.50 M	6.476,00

TIPO
TYPE

PVP €
Monof/Single ph

EVOPLUS D CIRCULADORAS DOBLES INST. COLECTIVAS



EVOPLUS D 40/340.65 M	4.195,00
EVOPLUS D 60/340.65 M	4.791,00
EVOPLUS D 80/340.65 M	5.149,00
EVOPLUS D 100/340.65 M	5.470,00
EVOPLUS D 120/340.65 M	5.928,00
EVOPLUS D 150/340.65 M	6.819,00

EVOPLUS D 40/360.80 M	5.159,00
EVOPLUS D 60/360.80 M	5.582,00
EVOPLUS D 80/360.80 M	6.007,00
EVOPLUS D 100/360.80 M	6.636,00
EVOPLUS D 120/360.80 M	7.302,00

EVOPLUS D 40/450.100 M	5.965,00
EVOPLUS D 60/450.100 M	6.439,00
EVOPLUS D 80/450.100 M	6.984,00
EVOPLUS D 100/450.100 M	7.688,00
EVOPLUS D 120/450.100 M	8.645,00



BOMBAS CIRCULADORAS PARA AGUA SANITARIA

VS 8-150 M	323,00
VS 16-150 M	340,00
VS 35-150 M	356,00
VS 65-150 M	368,00

KITS RACORESY BRIDAS



KIT RACORES 1"	17,00
KIT RACORES 1 1/4"	23,00
KIT RACORES 1" LATON	39,00
KIT BRIDAS DN-32 PN 10	70,00
KIT BRIDAS DN-40 PN 10	76,00
KIT BRIDAS DN-50 PN 10	84,00
KIT BRIDAS DN-65 PN 10	102,00
KIT BRIDAS DN-80 PN 10	108,00

TIPO TYPE	CV HP	PVP € Monof/Single ph	PVP € Trif/Three ph
--------------	----------	--------------------------	------------------------

ALM-ALP- CIRCULADORAS IN-LINE ROTOR SECO



ALM 200	0,08	666,00	585,00
ALP 800	0,5	574,00	538,00
ALM 500	0,33	777,00	704,00
ALP 2000	0,75	785,00	755,00

KL- CIRCULADORAS IN-LINE ROTOR SECO

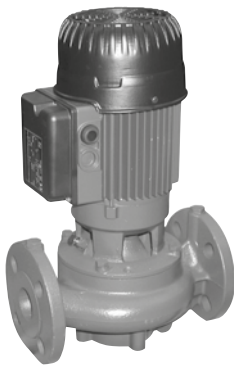

KLM 40-300	0,33	950,00	857,00
KLP 40-600	0,5	950,00	901,00
KLP 40-900	0,5	950,00	901,00
KLP 40-1200	0,75	1.007,00	966,00
KLP 40-1600	1	-	1.016,00
KLP 40-1800	1,15	-	1.016,00
KLM 50-300	0,33	1.418,00	1.309,00
KLM 50-600	0,33	1.418,00	1.309,00
KLP 50-900	1	1.448,00	1.532,00
KLP 50-1200	1	1.448,00	1.532,00
KLP 50-1600	1,5	-	1.600,00
KLP 50-2000	2,5	-	1.817,00
KLM 65-300	0,33	-	1.324,00
KLM 65-600	0,5	-	1.324,00
KLP 65-900	1,5	-	1.605,00
KLP 65-1200	1,5	-	1.605,00
KLP 65-1600	2,2	-	1.705,00
KLP 65-2000	2,7	-	1.817,00
KLM 80-300	0,33	-	1.338,00
KLM 80-600	1	-	1.555,00
KLP 80-900	2,5	-	1.960,00
KLP 80-1200	2,5	-	1.960,00
KLP 80-1600	3,5	-	2.344,00
KLP 80-2000	5	-	2.717,00

DKL- CIRCULADORAS DOBLES IN-LINE ROTOR SECO



DKLM 40-300	2 x 0,33	1.864,00	1.704,00
DKLP 40-600	2 x 0,5	1.864,00	1.788,00
DKLP 40-900	2 x 0,5	1.864,00	1.788,00
DKLP 40-1200	2 x 0,75	1.941,00	1.850,00
DKLP 40-1600	2 x 1	-	1.971,00
DKLP 40-1800	2 x 1,15	-	1.971,00
DKLM 50-300	2 x 0,33	2.725,00	2.518,00
DKLM 50-600	2 x 0,33	2.725,00	2.518,00
DKLP 50-900	2 x 1	2.772,00	2.969,00
DKLP 50-1200	2 x 1	2.772,00	2.969,00
DKLP 50-1600	2 x 1,5	-	2.977,00
DKLP 50-2000	2 x 2,5	-	3.379,00
DKLM 65-300	2 x 0,33	-	2.566,00
DKLM 65-600	2 x 0,5	-	2.566,00
DKLP 65-900	2 x 1,5	-	3.113,00
DKLP 65-1200	2 x 1,5	-	3.113,00
DKLP 65-1600	2 x 2,2	-	3.107,00
DKLP 65-2000	2 x 2,7	-	3.527,00
DKLM 80-300	2 x 0,33	-	2.597,00
DKLM 80-600	2 x 1	-	2.972,00
DKLP 80-900	2 x 2,5	-	3.767,00
DKLP 80-1200	2 x 2,5	-	3.767,00
DKLP 80-1600	2 x 3,5	-	4.505,00
DKLP 80-2000	2 x 5	-	5.216,00

	TIPO TYPE	CV HP	PVP € Motor IE-3
--	--------------	----------	---------------------

**CM
CIRCULADORAS IN-LINE A 1,450 RPM ROTOR SECO**

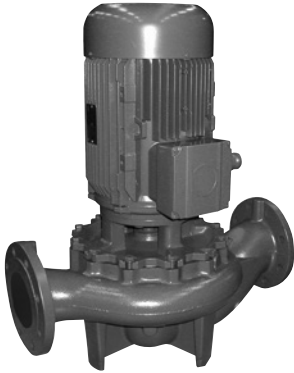

1.450 R.P.M.

PARA BOMBAS GEMELAS
CONSULTEN CON NUESTRO
DEPARTAMENTO COMERCIAL.

CM 40-440 T	1	1.307,00
CM 40-540 T	1	1.307,00
CM 40-670 T	1	1.348,00
CM 40-870 T	1	1.348,00
CM 40-1300 T	1	2.077,00
CM 40-1450 T	1,3	2.342,00
CM 50-510 T	1	1.393,00
CM 50-630 T	1	1.439,00
CM 50-780 T	1	1.439,00
CM 50-1000 T	1	1.439,00
CM 50-1270 T	1,5	2.710,00
CM 50-1420 T	1,5	2.710,00
CM-G 65-420 T	0,33	1.432,00
CM-G 65-540 T	0,5	1.464,00
CM-G 65-660 T	0,75	1.506,00
CM-G 65-760 T	0,75	1.541,00
CM-G 65-920 T	1	1.847,00
CM-G 65-1080 T	1,5	1.920,00
CM-G 65-1200 T	2	2.075,00
CM-G 65-1530 T	3	2.324,00
CM-G 65-1680 T	4	2.364,00
CM-G 65-2380 T	5,5	2.541,00
CM-G 80-550 T	0,75	1.890,00
CM-G 80-650 T	1	2.210,00
CM-G 80-740 T	1,5	2.282,00
CM-G 80-890 T	2	2.437,00
CM-G 80-1050 T	3	2.683,00
CM-G 80-1530 T	4	2.728,00
CM-G 80-1700 T	5,5	2.908,00
CM-G 80-2410 T	7,5	3.876,00
CM-G 80-2700 T	10	4.799,00
CM-G 80-3420 T	15	5.439,00
CM-G 100-510 T	1	2.633,00
CM-G 100-650 T	1,5	2.708,00
CM-G 100-660 T	2	2.860,00
CM-G 100-865 T	3	3.107,00
CM-G 100-1020 T	4	3.148,00
CM-G 100-1320 T	5,5	3.333,00
CM-G 100-1650 T	7,5	4.300,00
CM-G 100-2050 T	10	5.235,00
CM-G 100-2550 T	15	5.869,00
CM-G 100-3290 T	20	6.716,00
CM-G 100-3680 T	25	7.360,00
CM-G 100-4100 T	30	8.637,00
CM-G 125-1075 T	5,5	4.063,00
CM-G 125-1270 T	7,5	5.036,00
CM-G 125-1560 T	10	5.986,00
CM-G 125-2100 T	15	6.626,00
CM-G 125-2550 T	20	7.469,00
CM-G 125-3200 T	25	8.108,00
CM-G 125-3600 T	30	9.386,00
CM-G 125-4022 T	40	11.412,00
CM-G 150-955 T	7,5	5.743,00
CM-G 150-1322 T	10	6.907,00
CM-G 150-1600 T	15	7.716,00
CM-G 150-1950 T	20	8.354,00
CM-G 150-2200 T	25	9.202,00
CM-G 150-2405 T	30	9.840,00

TIPO
TYPE

CV
HP

PVP €
Motor IE-3

CP - CIRCULADORAS IN-LINE A 2,900 RPM ROTOR SECO

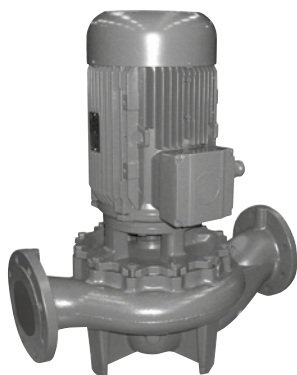

2.900 R.P.M.

PARA BOMBAS GEMELAS
CONSULTEN CON NUESTRO
DEPARTAMENTO COMERCIAL.

CP 40-1900 T	1	1.427,00
CP 40-2300 T	1,5	1.448,00
CP 40-2700 T	2	1.480,00
CP 40-3500 T	3	1.588,00
CP 40-3800 T	4	2.568,00
CP 40-4700 T	5,5	2.901,00
CP 40-5500 T	7,5	3.370,00
CP 40-6200 T	10	4.111,00
CP 50-2200 T	1,5	1.565,00
CP 50-2600 T	2	1.657,00
CP 50-3100 T	3	1.723,00
CP 50-4100 T	5,5	1.946,00
CP 50-4600 T	7,5	3.694,00
CP 50-5100 T	10	4.293,00
CP 50-5650 T	10	4.293,00
CP-G 65-1470 T	2	2.037,00
CP-G 65-1900 T	3	2.230,00
CP-G 65-2280 T	4	2.429,00
CP-G 65-2640 T	5,5	2.663,00
CP-G 65-3400 T	7,5	2.854,00
CP-G 65-4100 T	10	3.394,00
CP-G 65-4700 T	15	4.585,00
CP-G 65-5500 T	20	5.674,00
CP-G 65-6150 T	25	6.065,00
CP-G 65-7350 T	30	6.650,00
CP-G 65-9250 T	40	7.628,00
CP-G 80-1400 T	3	2.429,00
CP-G 80-1700 T	4	2.626,00
CP-G 80-2050 T	5,5	2.814,00
CP-G 80-2400 T	7,5	3.297,00
CP-G 80-2770 T	10	3.950,00
CP-G 80-3250 T	15	4.670,00
CP-G 80-4000 T	20	5.862,00
CP-G 80-5150 T	25	6.951,00
CP-G 80-5650 T	30	7.341,00
CP-G 80-6850 T	40	8.150,00
CP-G 80-8600 T	50	10.494,00
CP-G 80-9600 T	60	12.631,00
CP-G 80-10200 T	75	15.237,00
CP-G 100-1600 T	5,5	3.554,00
CP-G 100-1950 T	7,5	4.039,00
CP-G 100-2350 T	10	4.717,00
CP-G 100-2400 T	15	5.434,00
CP-G 100-3050 T	20	6.216,00
CP-G 100-3550 T	25	7.304,00
CP-G 100-3850 T	30	7.697,00
CP-G 100-4800 T	40	8.802,00
CP-G 100-5600 T	50	10.585,00
CP-G 100-6300 T	60	12.711,00
CP-G 100-8300 T	75	15.324,00
CP-G 125-4750 T	50	11.886,00
CP-G 125-5300 T	60	14.020,00
CP-G 125-5800 T	75	16.626,00

PAG. CAT. CAT. PAGE	TIPO TYPE	PVP €
------------------------	--------------	-------

FILTROS DE CARTUCHO



FILTRO 3 PIEZAS 10" LARGO 1"	49,00
CART. PP. BOBINADO 50 MICRAS 1"	13,00
CART. PP. BOBINADO 9" 3/4-1 MICRA	17,00
CART. PP. BOBINADO 9" 3/4-5 MICRA	16,00
CART. MALLA LAVABLE 60 MICRAS 1"	28,00
CART. CARBON ACTIVO 60 MICRAS 1"	31,00
CART. POLIFOSFATOS 1"	46,00

TIPO TYPE	PVP €
--------------	-------



PRECONTROL-MASCONTROL-CONTROLPRESS

PRECONTROL CON CABLES	146,00
MASCONTROL	232,00
CONTROLPRESS REGULABLE	347,00
SACIPRESS CON CABLES	92,00
AUTOPRESS CON CABLES	92,00
KIT CONECTOR 3 PIEZAS	9,00

TIPO TYPE	PVP € 10 Bar	PVP € 16 Bar	PVP € 25 Bar
--------------	-----------------	-----------------	-----------------

EVO- DEPOSITOS DE MEMBRANA RECAMBIABLE



EVO 8 LTS EXPANSOR	49,00	-	-
EVO 12 LTS EXPANSOR	54,00	-	-
EVO 19 LTS EXPANSOR	67,00	-	-
EVO 24 LTS EXPANSOR	50,00	-	-
EVO 35 LTS EXPANSOR	105,00	-	-
EVO 50 LTS EXPANSOR	116,00	216,00	535,00*
EVO 50 LTS VERTICAL	145,00	224,00	535,00*
EVO 80 LTS VERTICAL	259,00	-	-
EVO 100 LTS VERTICAL	278,00	390,00	1.102,00*
EVO 150 LTS VERTICAL	374,00	446,00	1.420,00*
EVO 200 LTS VERTICAL	527,00	807,00	1.878,00*
EVO 300 LTS VERTICAL	579,00	946,00	2.314,00*
EVO 500 LTS VERTICAL	842,00	1.335,00	3.134,00*
EVO 750 LTS VERTICAL	1.315,00	2.629,00	4.563,00*
EVO 1000 LTS VERTICAL	1.893,00	3.328,00	5.468,00*
EVO 1500 LTS VERTICAL	3.321,00	4.553,00	7.667,00*
EVO 24 LTS HORIZONTAL	92,00	-	-
EVO 50 LTS HORIZONTAL	142,00	-	-
EVO 80 LTS HORIZONTAL	274,00	-	-
EVO 100 LTS HORIZONTAL	295,00	-	-

*Versiones a 25 bar se piden bajo demanda

*25 bar pressure tanks under demand

	TIPO TYPE	PRESIÓN PRESSURE	PVP €
--	--------------	---------------------	-------

AIRMAX- DEPOSITOS DE MEMBRANA FIJA



AIRMAX 3 Lts EXP	10 Bar	45,00
AIRMAX 8 Lts EXP	10 Bar	60,00
AIRMAX 12 Lts EXP	10 Bar	67,00
AIRMAX 18 Lts EXP	10 Bar	75,00
AIRMAX 24 Lts EXP	10 Bar	79,00
AIRMAX 40 Lts EXP	10 Bar	108,00
AIRMAX 60 Lts EXP	10 Bar	175,00
AIRMAX 60 Lts VER	10 Bar	185,00
AIRMAX 80 Lts VER	10 Bar	250,00
AIRMAX 100 Lts VER	10 Bar	317,00
AIRMAX 160 Lts VER	10 Bar	497,00
AIRMAX 200 Lts VER	10 Bar	728,00
AIRMAX 300 Lts VER	10 Bar	987,00
AIRMAX 450 Lts VER	10 Bar	1.502,00
AIRMAX 24 Lts HOR	10 Bar	101,00
AIRMAX 60 Lts HOR	10 Bar	199,00
AIRMAX 80 Lts HOR	10 Bar	260,00
AIRMAX 100 Lts HOR	10 Bar	338,00

ACCESORIOS DE INSTALACIÓN



PRESOST FSG-2	25,00
PRESOST FYG-22	41,00
PRESOST FYG-32	48,00
PRESOST FSG-2 / M4	77,00
PRESOST FXG-2 (XMXA06L2135)	77,00
PRESOST FXG-4 (XMXA12L2135)	79,00
TELEM 6	35,00
TELEM 12	38,00
TELEM 25	108,00
RACOR 5 VIAS	18,50
MANOMETRO	9,30
MANOMETRO GLICERINA	18,50
INYEKTOR AIRE MINI (0-500 LTS)	123,00
INYEKTOR AIRE MIDI (0-1000 LTS)	228,00
INYEKTOR AIRE MAXI (1000-2000 LTS)	346,00
INTERRUPTOR SACI 2 (3 mts cable)	23,50
INTERRUPTOR SACI 2 (5 mts cable)	31,00
INTERRUPTOR SACI 2 (10 mts cable)	41,00
KIT EMPALME TERMORETRACTIL	14,00
EMPALME CONEXION DE RESINA M11	34,00
EMPALME CONEXION DE RESINA M12	52,00
CAUDALIMETRO 1-1/2' -50 MM (3-21 M3/H) F30050M	318,00
CAUDALIMETRO 2' - 63 MM (6-28 M3/H) F30063M	337,00
CAUDALIMETRO 2-1/2' -75 MM (9-42 M3/H) F30075M	361,00
CAUDALIMETRO 3'-90 MM (12-51 M3/H) F30090M	378,00
CAUDALIMETRO 4'-110 MM (36-108 M3/H) F30110M	395,00
CAUDALIMETRO 6'-160 MM (54-192 M3/H) F30160M	603,00
CAUDALIMETRO 8'-200 MM (90-306 M3/H) F30200M	668,00
TAPA POZO POLIESTER 1 1/4" DIAM 210	41,00
TAPA POZO GALVANIZADA 1 1/4" DIAM 210	65,00
TAPA POZO AISI-304 1 1/4" DIAM 205	112,00
ROLLO 100 MTS CUERDA BLANCA DIAM 10 MM	160,00
ROLLO 300 MTS CUERDA BLANCA DIAM 10 MM	350,00

CONDICIONES GENERALES DE VENTA

PEDIDOS

Los pedidos se cursarán preferentemente por correo electrónico, mencionando el número de pedido, la referencia del producto y la dirección de envío, y se registrarán por la tarifa de precios que esté en vigor.

Para los pedidos de material fabricados bajo expresa demanda (material no estándar) se requerirá de la oferta correspondiente sellada y firmada por el comprador.

BOMBAS SACI, S.A. se reserva el derecho de suministrar productos a aquellos clientes que en el momento de la entrega mantengan saldos impagados con nuestra firma. Mientras el cliente no haya satisfecho el valor total de la mercancía, BOMBAS SACI se reserva el dominio de la misma.

PLAZOS DE ENTREGA

Los plazos de entrega facilitados por nuestro departamento comercial son orientativos, y siempre entendiéndose la fecha informada como fecha de salida del material de nuestras instalaciones, por lo que no se atenderán reclamaciones por demoras en el tiempo de entrega.

PORTES DE ENVÍO

Los portes para envíos nacionales serán pagados cuando el importe neto de la factura sea superior a 600,00 €. Si el importe es menor, será enviado a portes debidos, o previo aviso se les cargará en factura una cantidad en concepto de portes. En caso de envío de material voluminoso (filtros y acumuladores entre otros) los costes de envío serán establecidos de antemano.

El receptor se verá obligado a revisar, en presencia del transportista, las condiciones del material recibido en sus instalaciones inmediatamente. En caso de encontrar material visiblemente dañado o faltante a la vista, se debe registrar convenientemente el hecho en el albarán del transportista y enviar notificación a BOMBAS SACI de la incidencia.

En caso de daños no visibles, se deberá enviar notificación por escrito al transportista y a BOMBAS SACI antes de las 24 horas siguientes a la fecha de recepción del material, o no se podrá efectuar reclamación alguna a posteriori.

DEVOLUCIONES

No se admitirán devoluciones de material transcurridos 15 días desde su recepción.

En caso de devolución dentro de este plazo, el material deberá sernos remitido perfectamente embalado y a portes pagados, o bien recogido por nuestra agencia de transporte previo acuerdo con nuestro departamento de incidencias. Se rechazará toda devolución a portes debidos.

Una vez recibido el material, se revisará su estado y se cargarán los conceptos necesarios para volver a dejar el material y su embalaje en perfecto estado.

Se deberán indicar en la documentación datos referentes a su expedición y facturación (nº de albarán, fecha de albarán, nº factura, etc...) y en ningún caso se aceptarán devoluciones que no hayan sido previamente acordadas.

Los productos de fabricación especial no están sujetos a devolución salvo defecto de fabricación, o salvo previo acuerdo con nuestro departamento de incidencias, y en este caso, se aplicará un demérito según causa.

GARANTÍAS

BOMBAS SACI, S.A. garantiza todos sus productos contra cualquier defecto de fabricación por un periodo de 3 años a partir de la fecha de factura del producto.

Sólo se aceptarán en garantía las piezas deterioradas y no el conjunto completo. La garantía queda limitada a la sustitución de las piezas defectuosas y mano de obra de sustitución de las mismas en nuestros talleres autorizados, y en ningún caso se aceptarán cargos en concepto de mano de obra, indemnizaciones, desplazamientos o mano de obra de montaje y desmontaje de las bombas en las instalaciones del cliente.

PARA MÁS INFORMACIÓN:

www.sacipumps.com
saci@sacipumps.com

BOMBAS SACI S.A. no se hace responsable de las posibles inexactitudes contenidas en el presente documento, debidas a errores de impresión o de transcripción, y se reserva el derecho de aportar a sus productos las modificaciones que considere necesarias y que no perjudiquen las características esenciales de dichos productos.

GENERAL SALES CONDITIONS

ORDERS

Orders will preferably be placed by email, mentioning the order number, the product reference, and the shipping address, and will be registered the actual price list.

For orders of material manufactured on demand (non-standard material), the corresponding offer sealed and signed by the buyer will be required.

SACI PUMPS reserves the right to supply products to those customers who at the time of delivery have unpaid balances with our Company. As long as the client has not satisfied the total value of the merchandise, SACI PUMPS reserves the domain of the same.

DELIVERY TIME

The delivery times provided by our commercial department are indicative, and the informed date is always understood as the date in which the goods are ready to be collected, so claims for delays in delivery time will not be addressed.

DELIVERY TERMS

International shipments are always ExWorks.

SACI PUMPS can take care of the documentation and shipment of the products prior agreement with our export department. In this case, the shipping costs, documents and official legalizations necessary for the export of the material will always be borne by the buyer and will be charged on the invoice.

RETURNS

Material returns will not be accepted after 15 days from receipt.

In case of return within this period, the material must be sent to us perfectly packed and postage paid, or picked up by our transport agency prior agreement with our export department. Any return postage due will be refused. Once the material is received, its condition will be reviewed and the necessary concepts will be charged to return the material and its packaging in perfect condition.

Data referring to its issuance and invoicing (invoice number) must be indicated in the documentation.

Specially manufactured products are not subject to return except for a manufacturing defect, or unless previously agreed with our export department, and in this case, a demerit will be applied depending on the cause.

WARRANTY

SACI PUMPS guarantees all its products against any manufacturing defect for a period of 2 years from the invoice date of the product.

Only damaged parts and not the complete set will be accepted under warranty. The warranty is limited to the replacement of defective parts and labour to replace them in our authorized workshops, and in any case we will accept charges for labour, compensation, travel or assembly and disassembly labour of the pumps at the customer's premises.

FOR MORE INFORMATION:

www.sacipumps.com
saci@sacipumps.com

SACI PUMPS is not responsible for possible inaccuracies contained in this document, due to printing or transcription errors, and reserves the right to make any modifications to its products that it deems necessary and that do not harm the essential characteristics of said products.

Innovadores por excelencia
La calidad de producto es nuestro compromiso
Su satisfacción es nuestra motivación
Comprometidos con el medio ambiente

*Innovators par excellence
Product quality is our commitment
Your satisfaction is our motivation
Committed to the environment*





BARCELONA

C./ Can Muntanyola, 4-22
Pol. Ind. Palou Nord
08401 Granollers, Barcelona- Spain
Tel. +34 93 384 23 51
saci@sacipumps.com

A CORUÑA

Poligono Pocomaco, Parcela D-31
15190 A Coruña- Spain
Tel. +34 981 29 96 88
sacicoruna@sacipumps.com

LEVANTE

C/ Mónaco, Nave 39
Pol. Ind. Ciudad del Transporte II
12006 Castellón de la Plana- Spain
Tel. +34 964 33 44 66
sacilevante@sacipumps.com

www.sacipumps.com

